



**ENERGY FRONTIER RESEARCH CENTER**  
for gas separations relevant to clean air technologies



new materials for capture...

new methods to characterize...

new ways to compute...

new ways to communicate...

# new materials for capture...

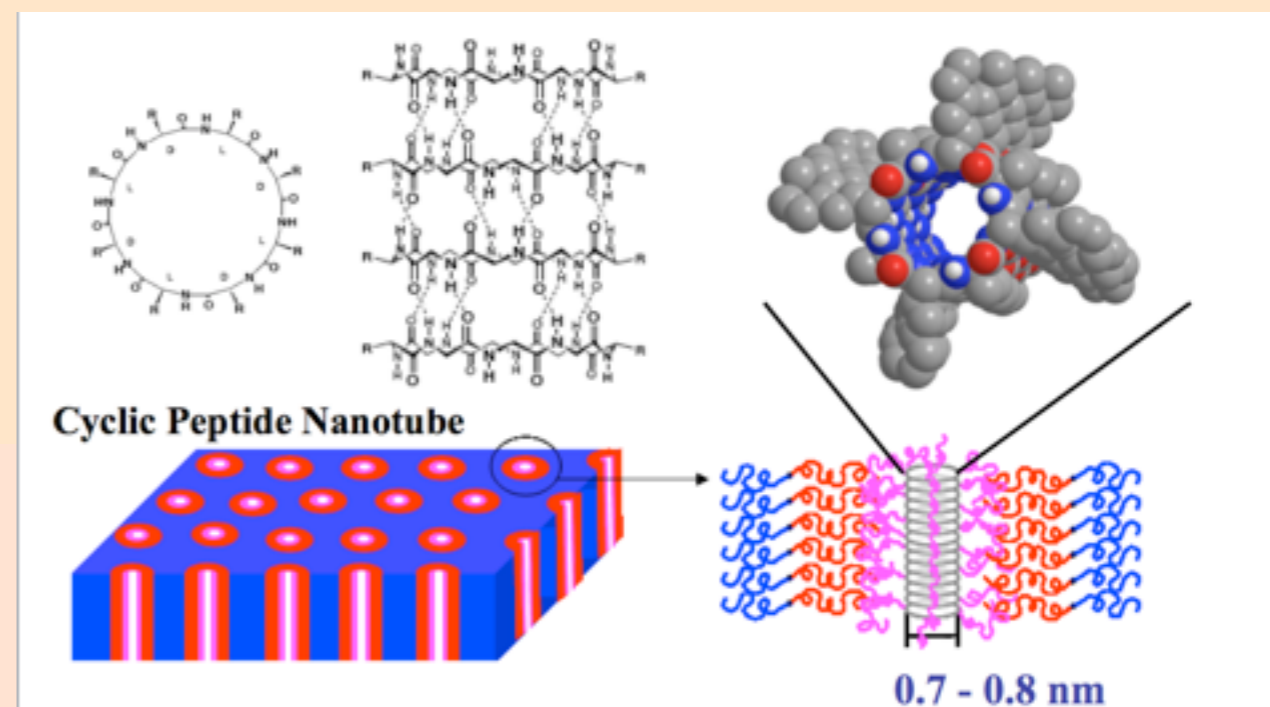
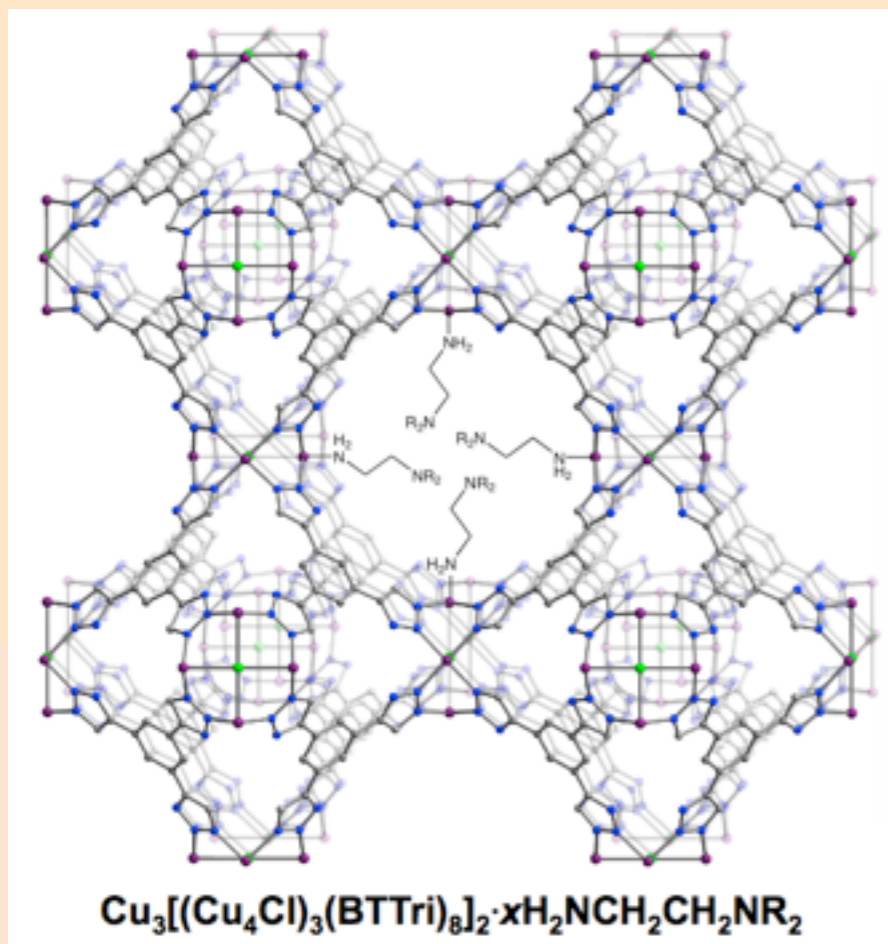
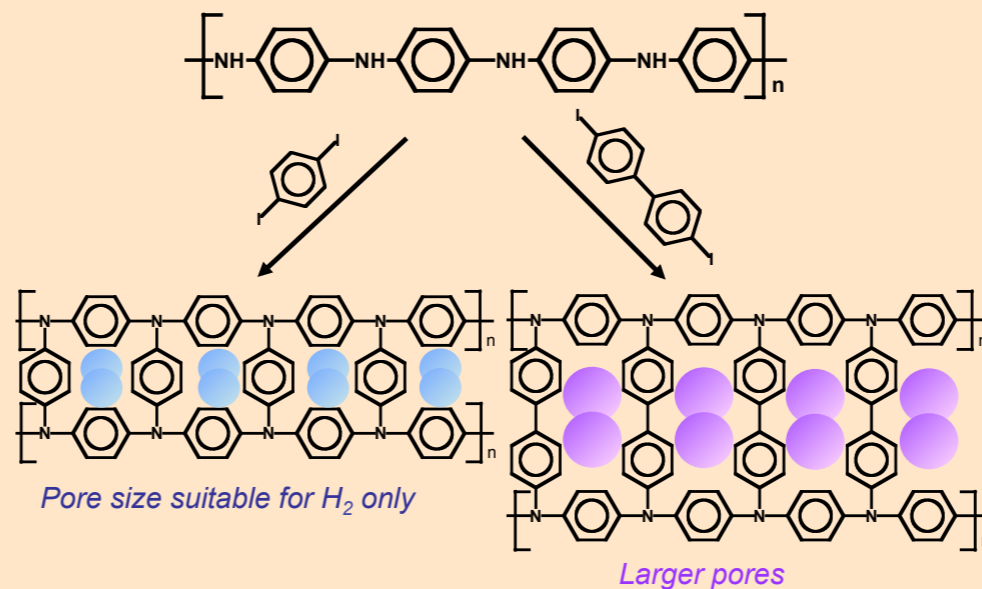
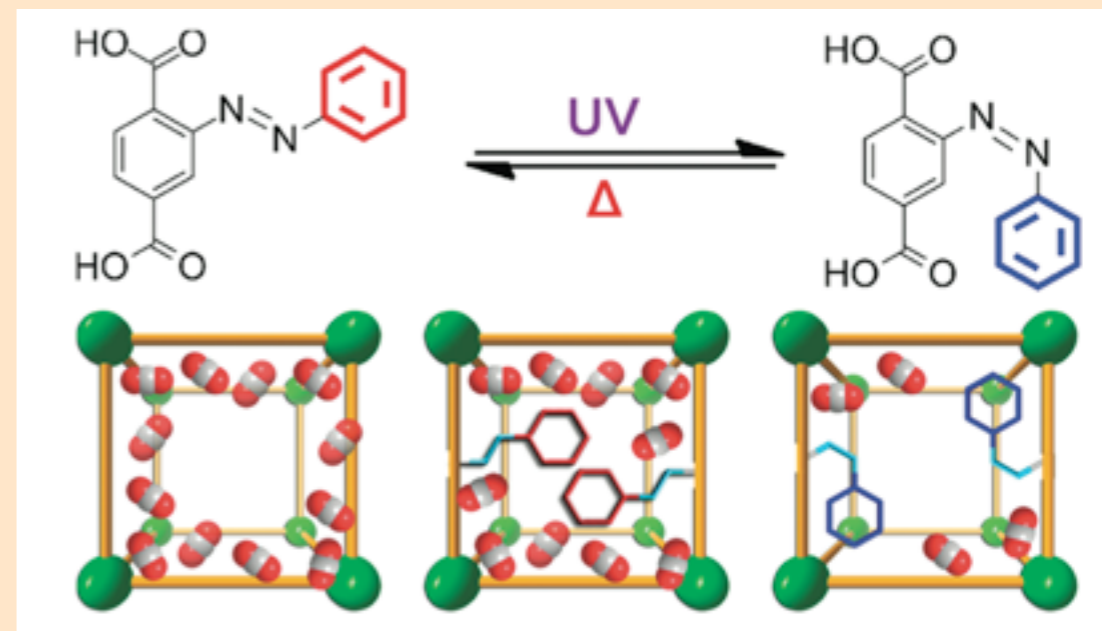
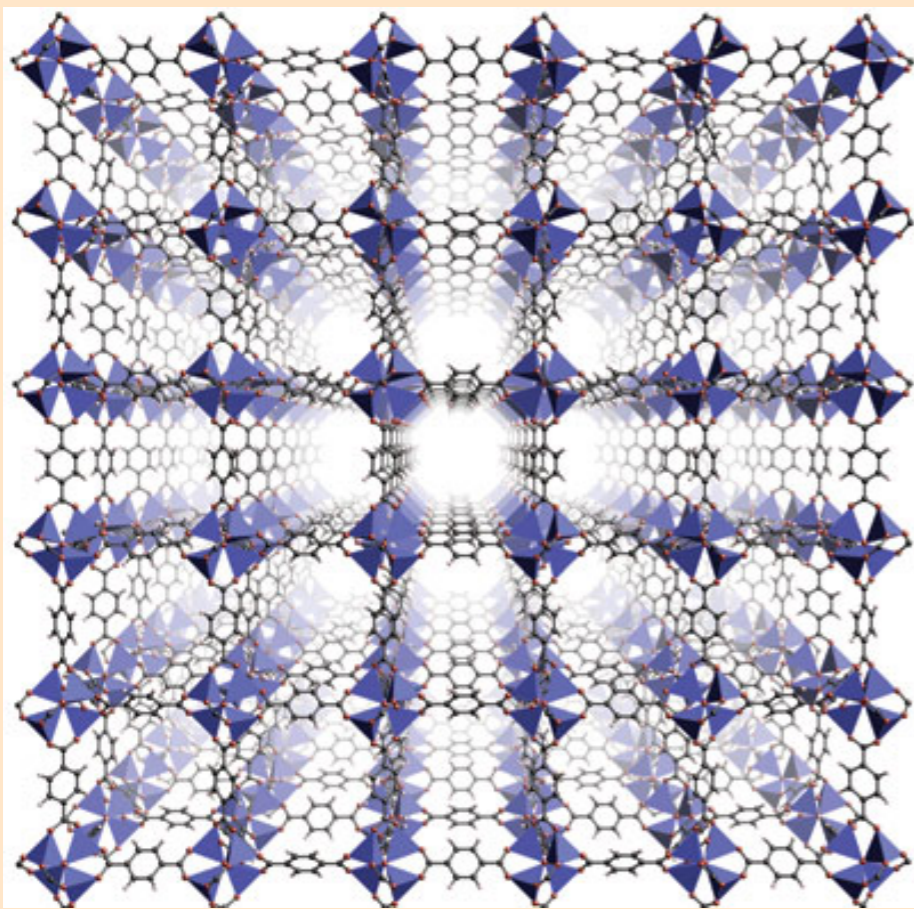

# new methods to characterize...

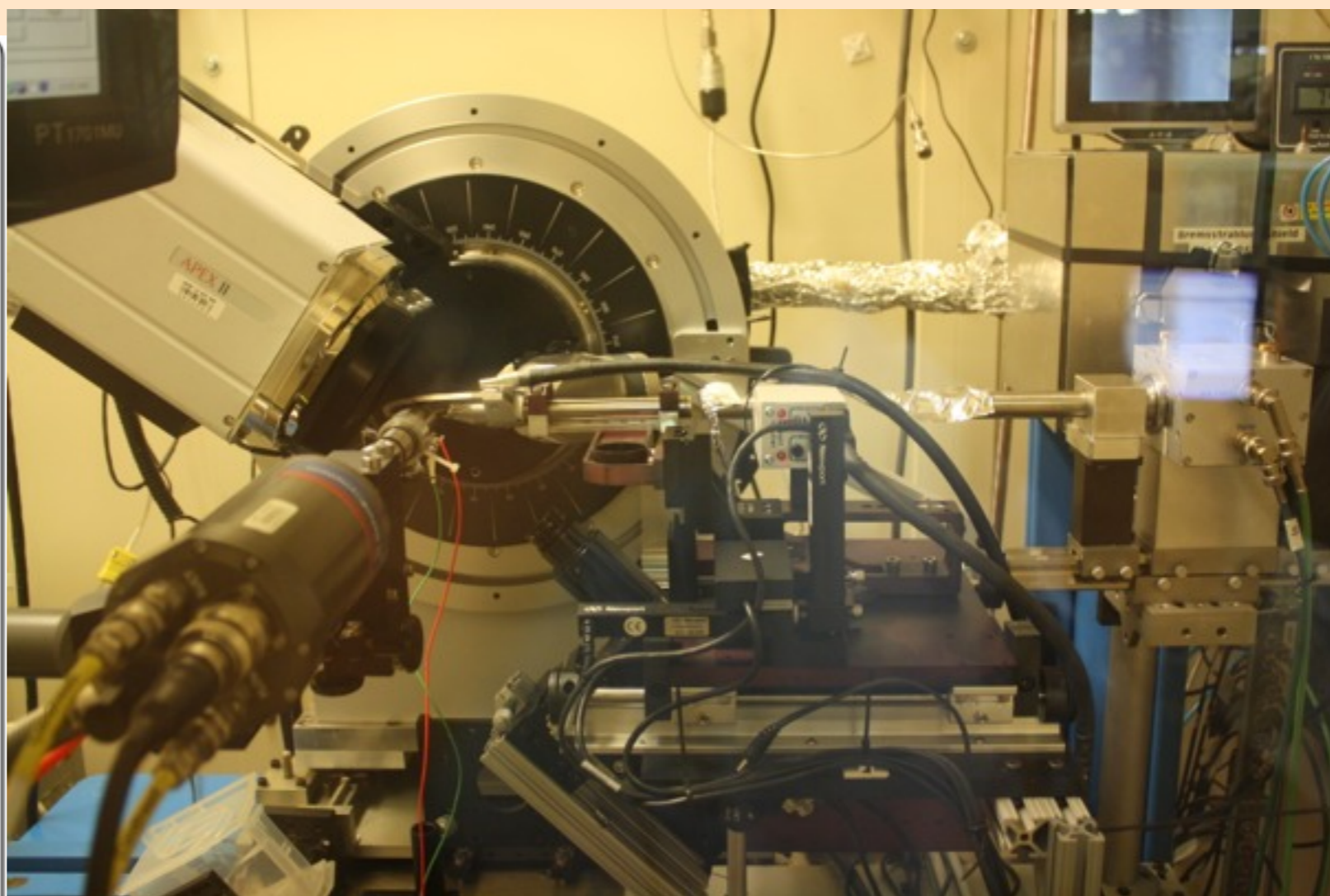
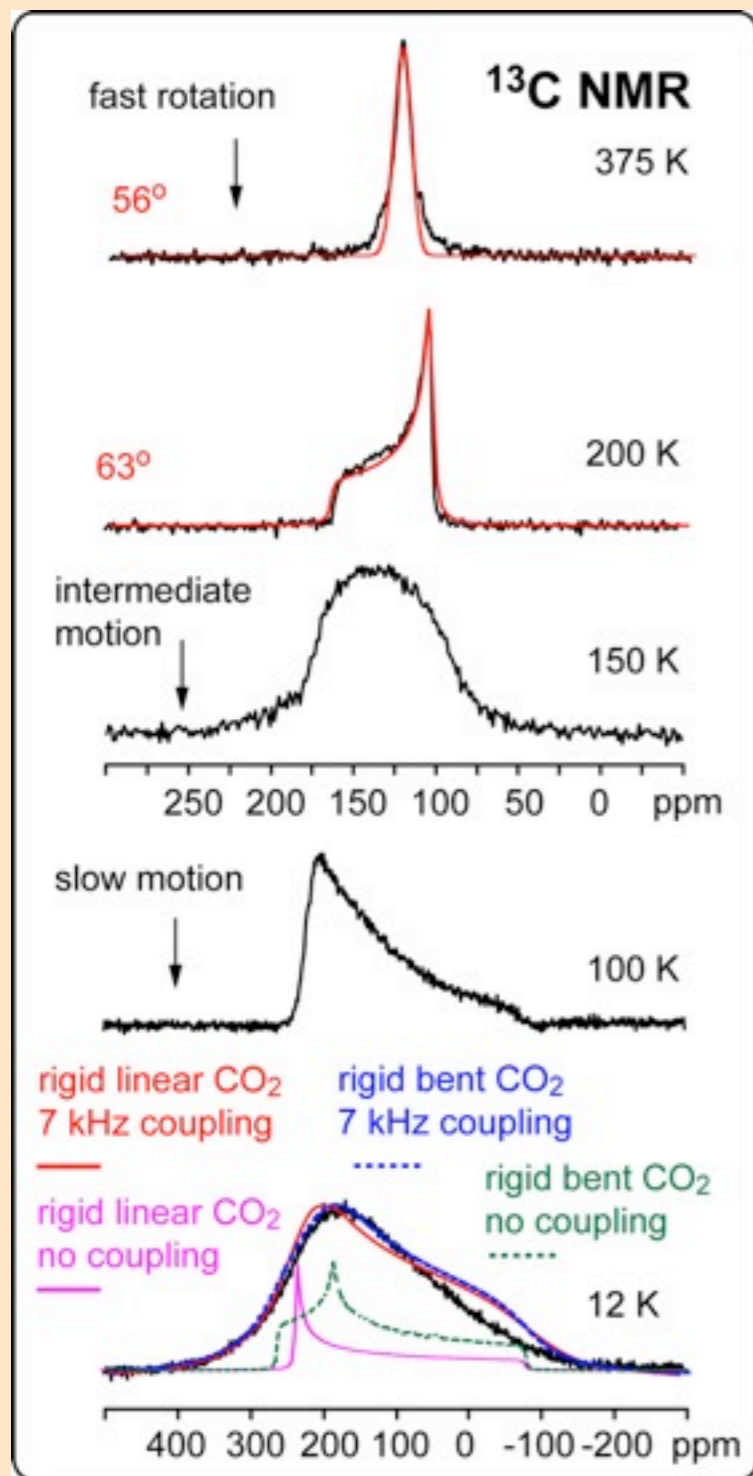

# new ways to compute...

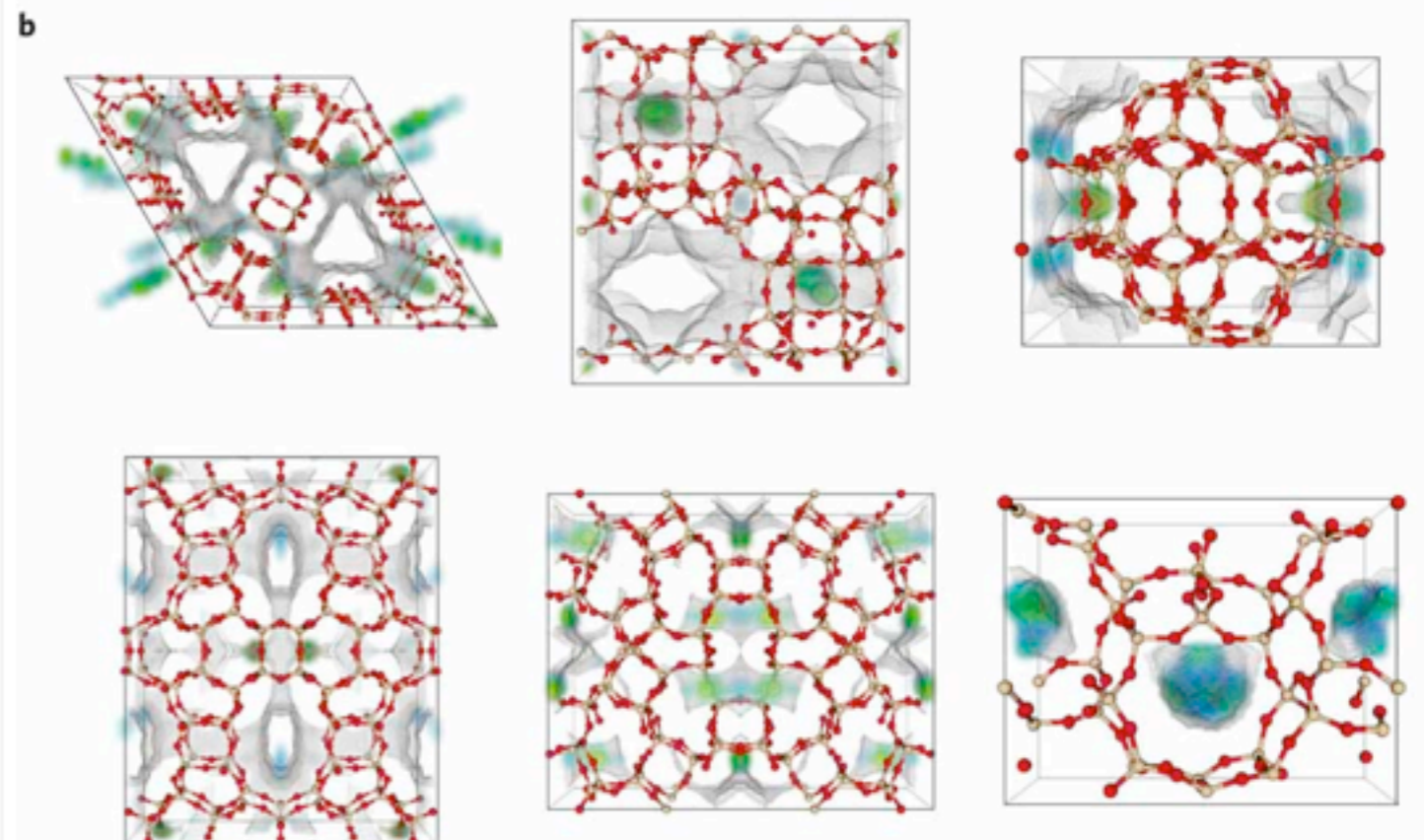
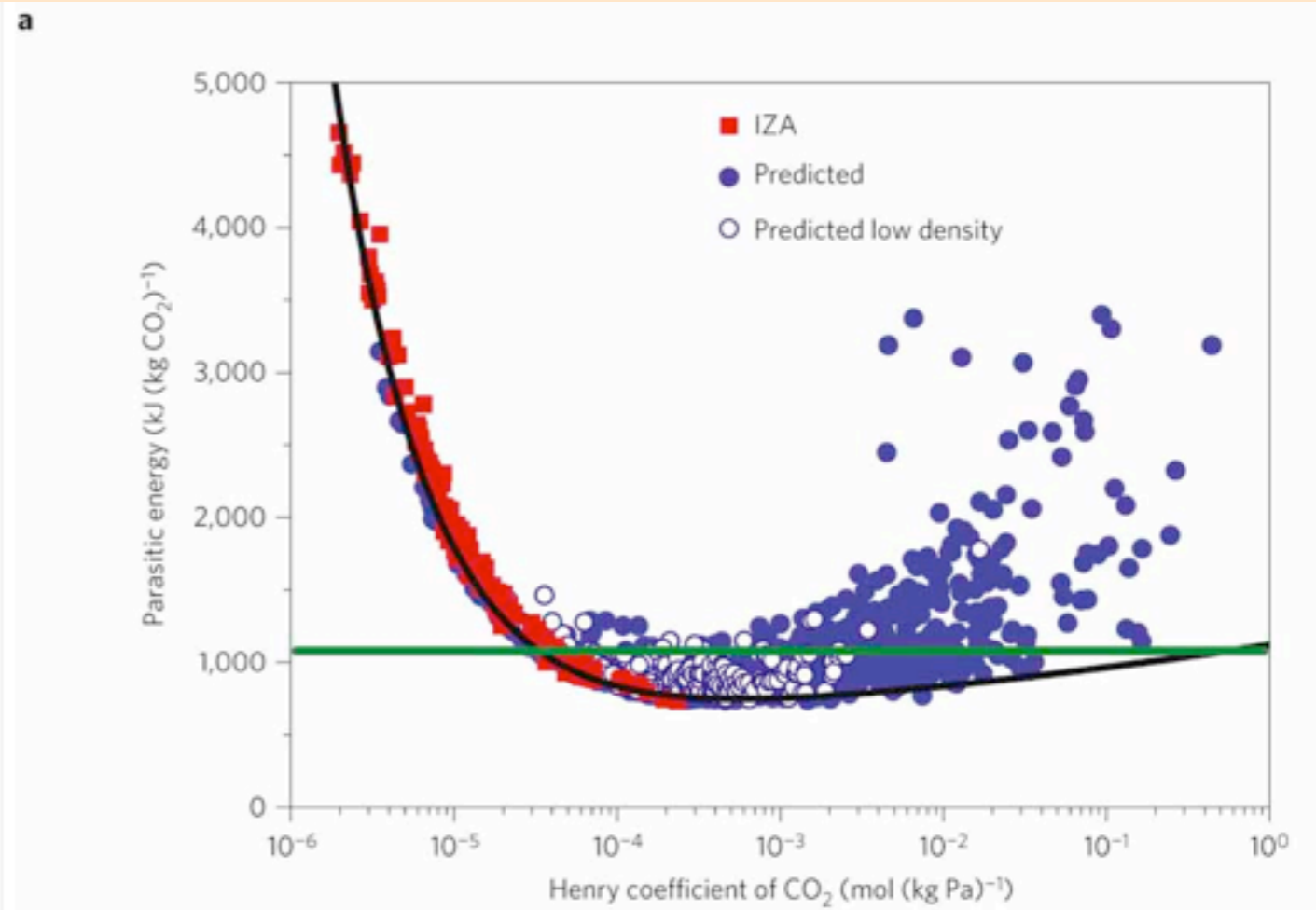
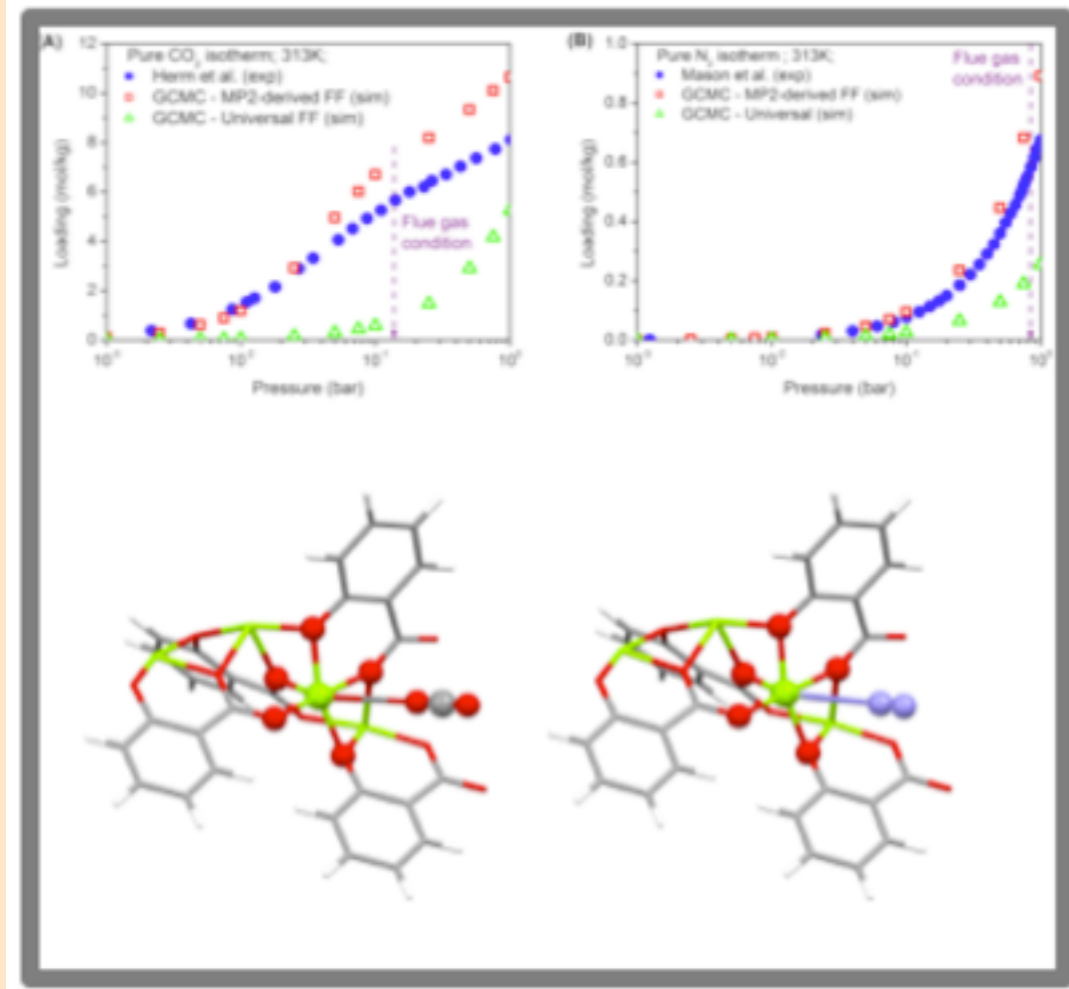

new ways to communicate...

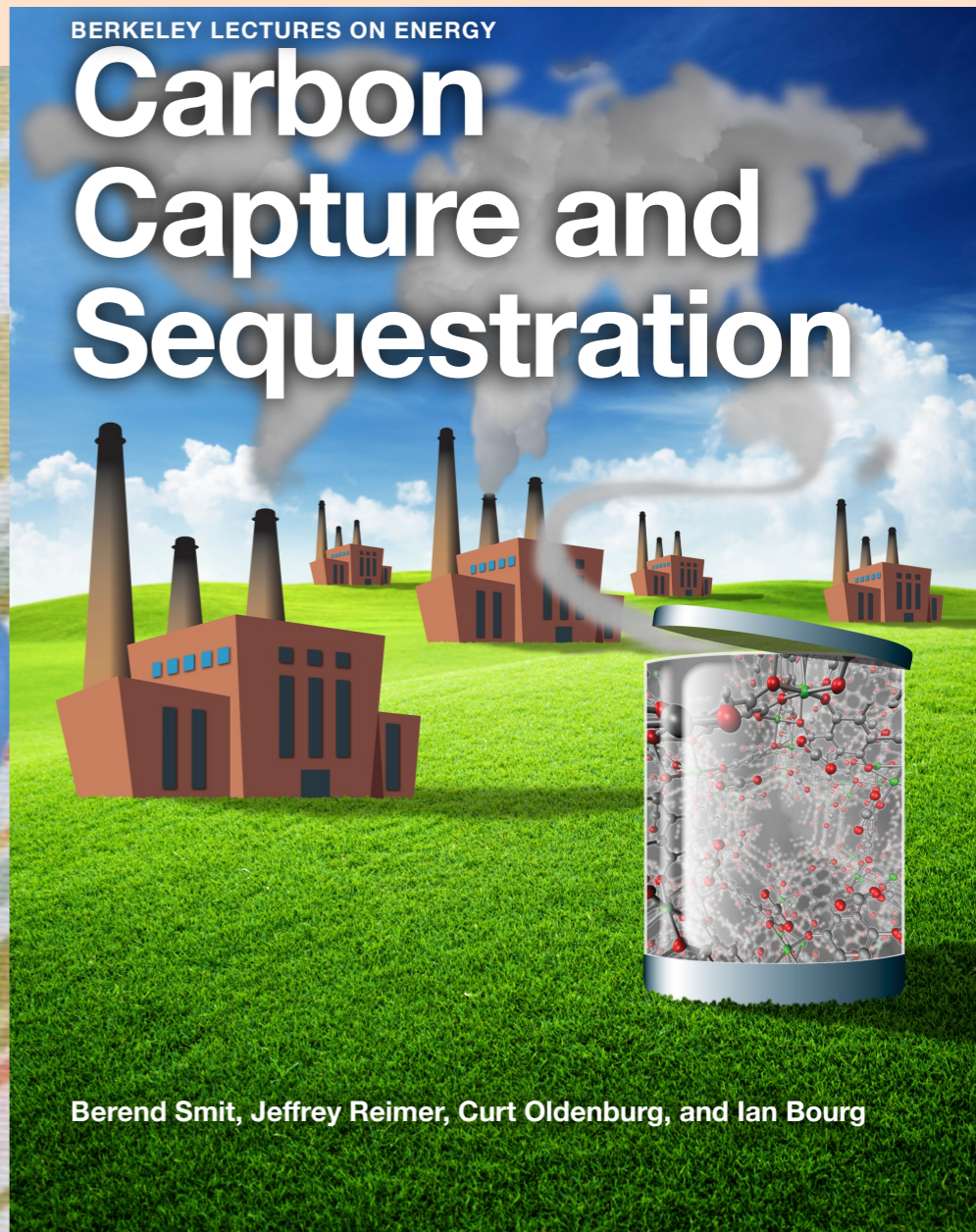

# "MOF-5"

**a**

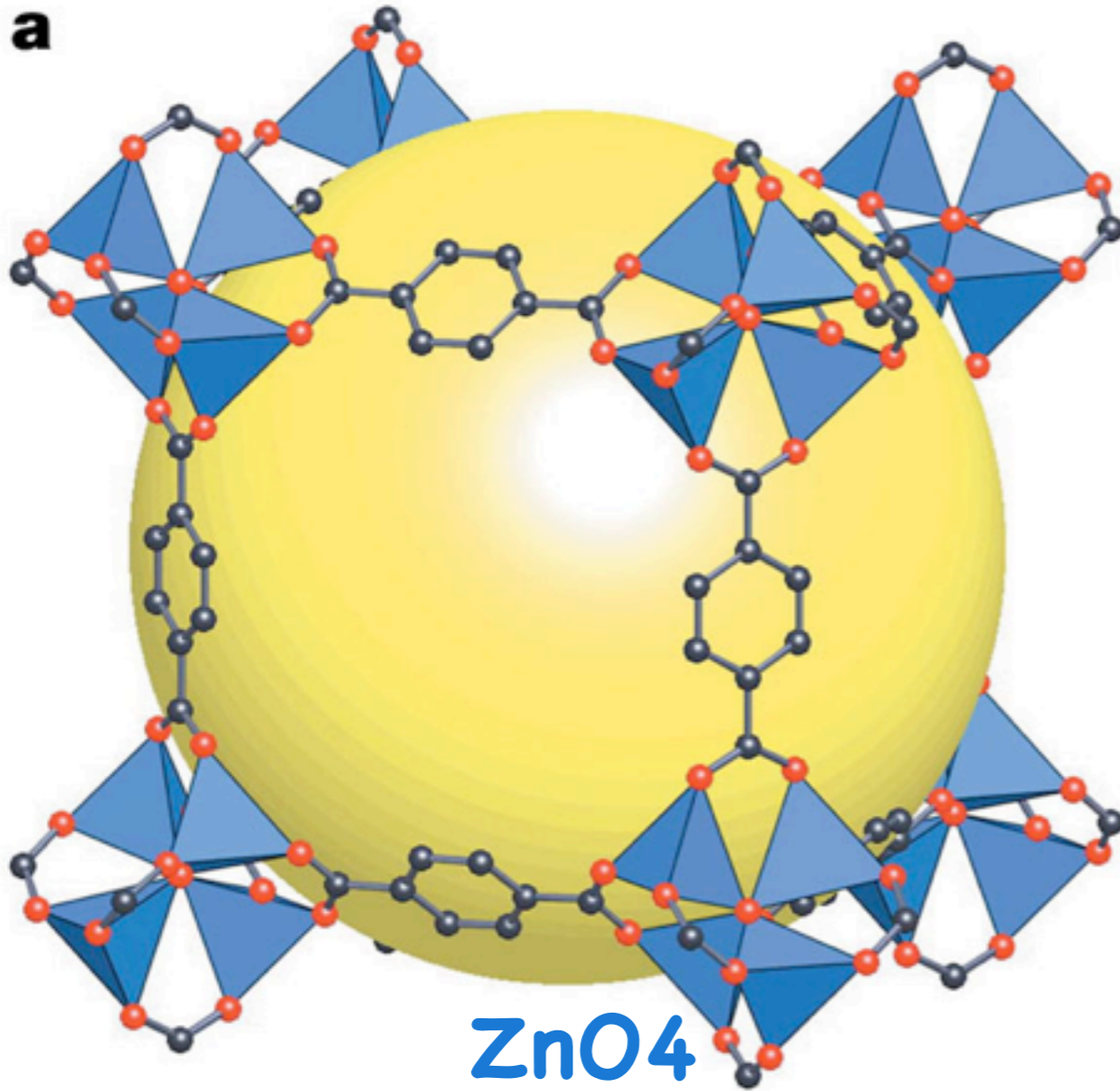

**ZnO<sub>4</sub>  
tetrahedra**

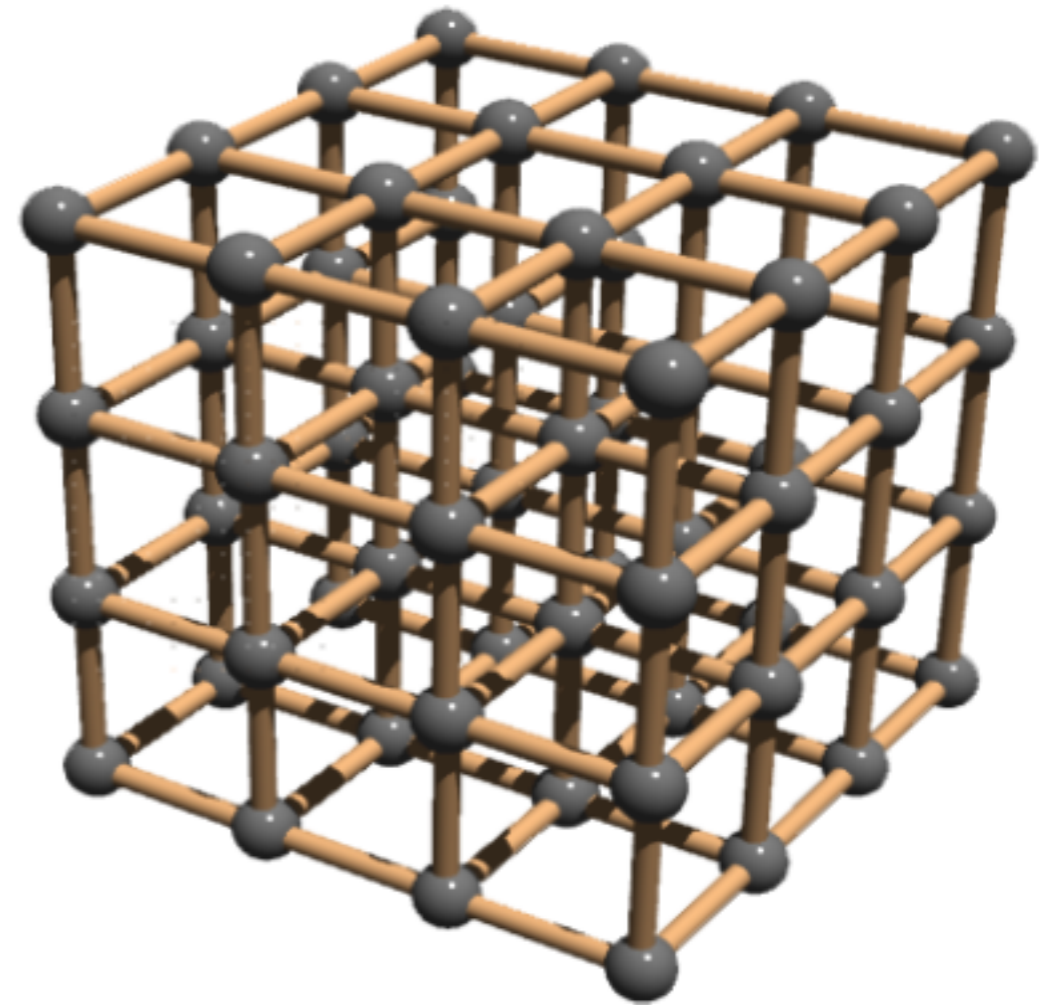

# "MOF-5"

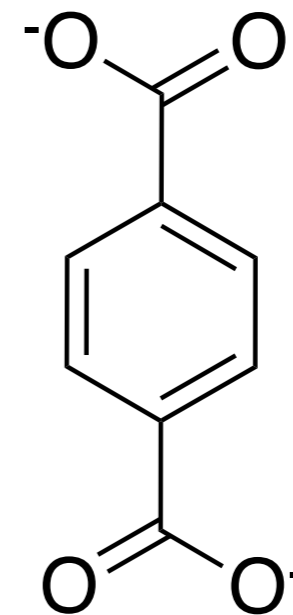
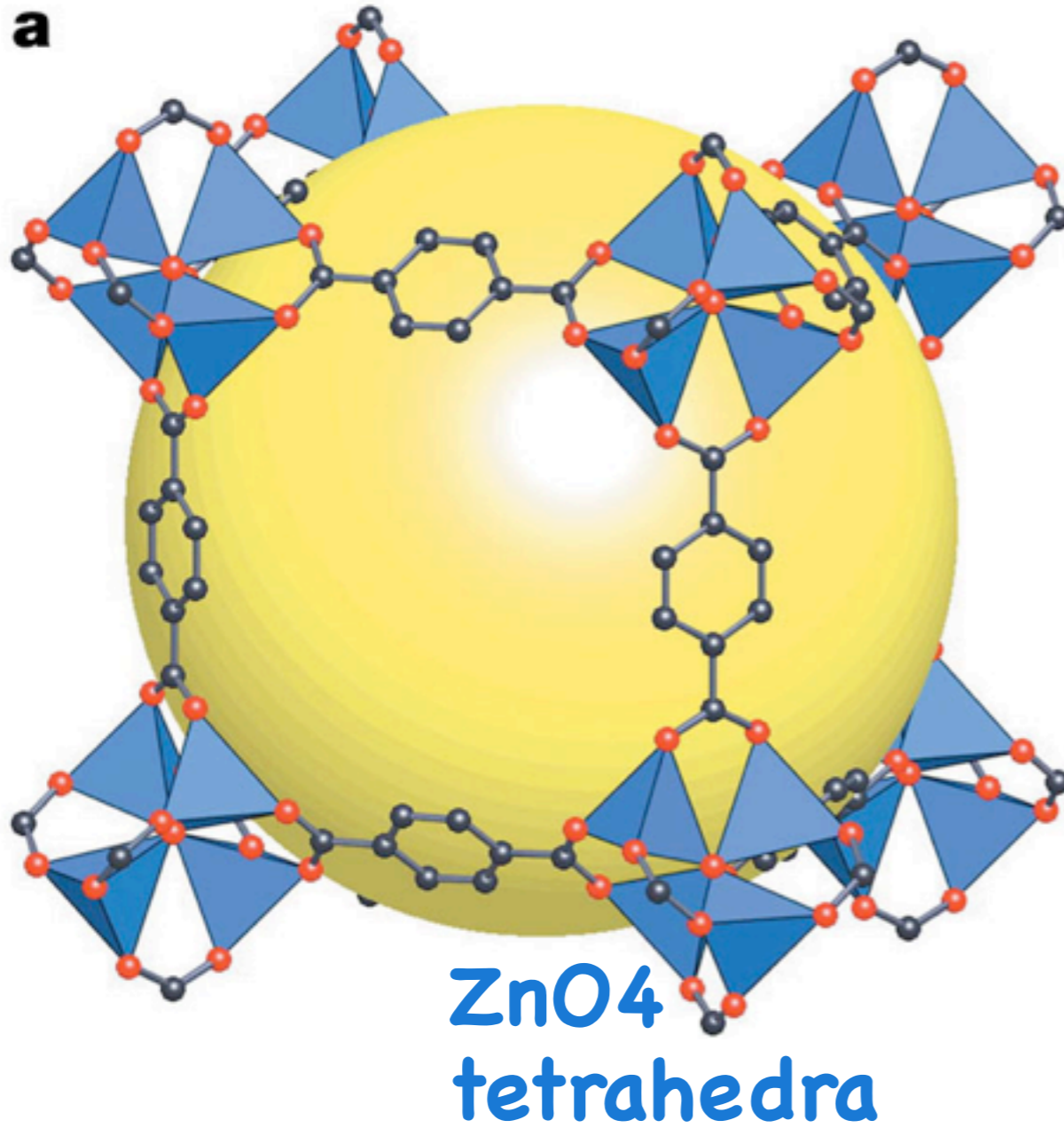

**organic  
linker**



Prof. Omar Yaghi  
LBNL and Dept. of  
Chemistry, UCB

MTV-MOFs: MOFs with  
multivariate organic linkers

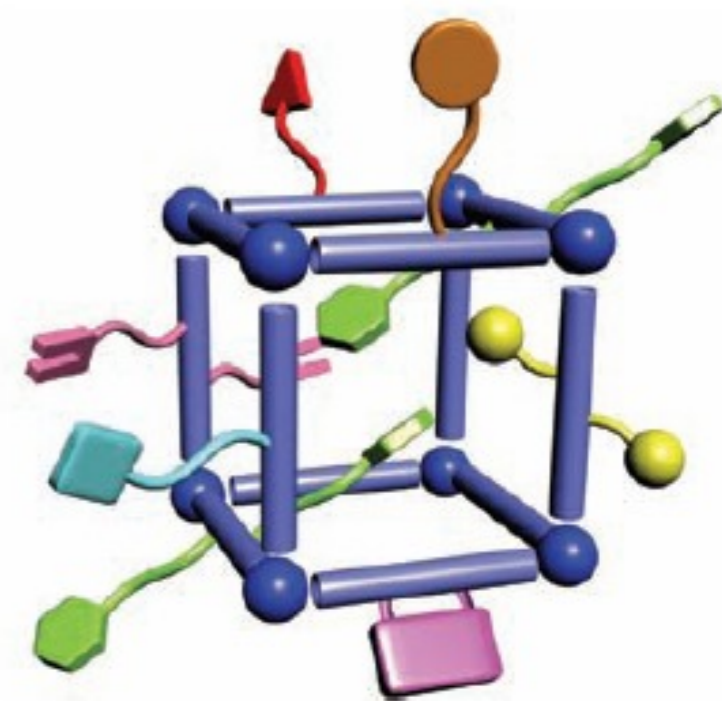

MTV-MOF-5 structure  
with eight different functionalities





Prof. Omar Yaghi  
LBNL and Dept. of  
Chemistry, UCB

## MTV-MOFs: MOFs with multivariate organic linkers

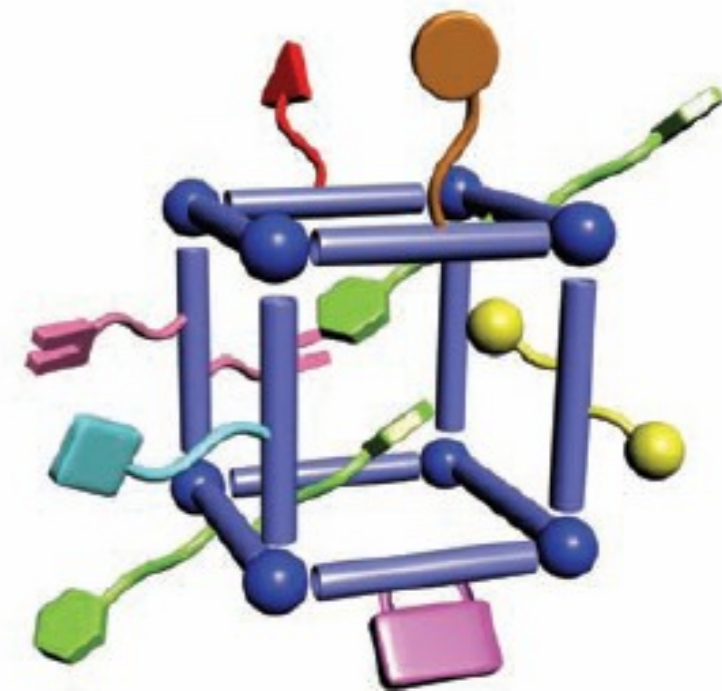

MTV-MOF-5 structure  
with eight different functionalities

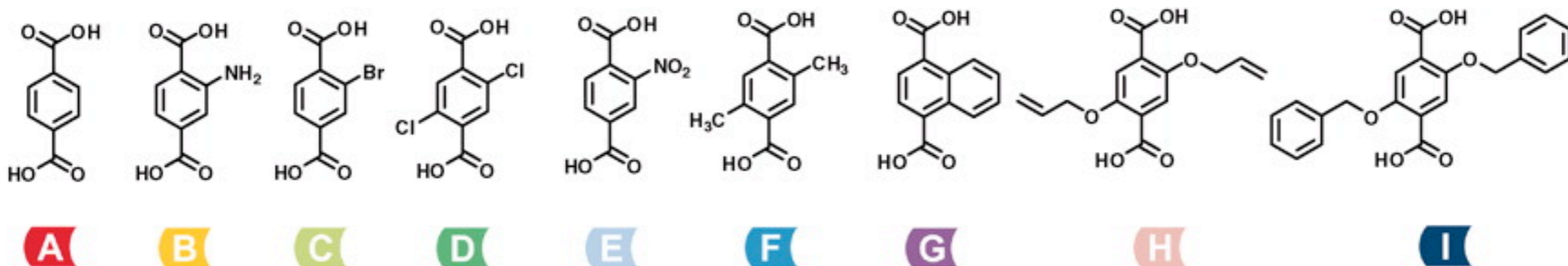
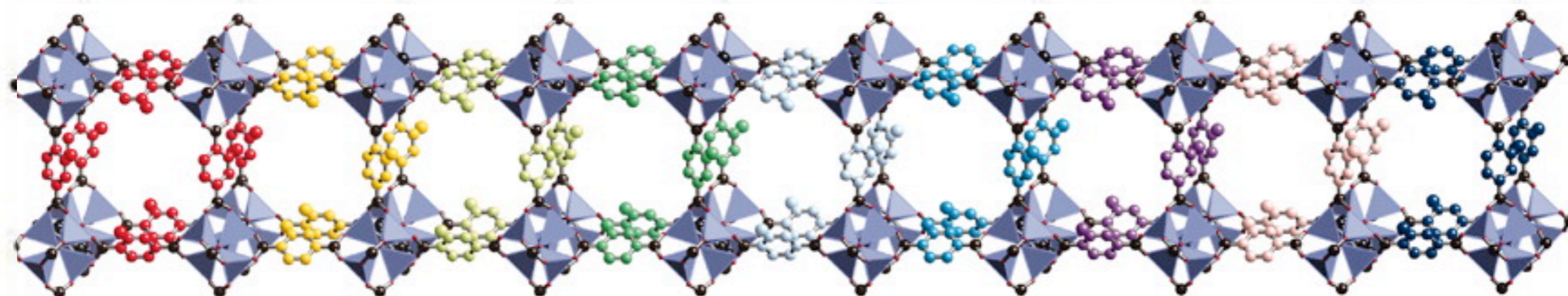

❖ Certain MTV-MOFs have better H<sub>2</sub> and CO<sub>2</sub> adsorption  
properties than MOFs with a single type of linker.

*Deng. et al.  
Science 2010*



Prof. Omar Yaghi  
LBNL and Dept. of  
Chemistry, UCB

## MTV-MOFs: MOFs with multivariate organic linkers

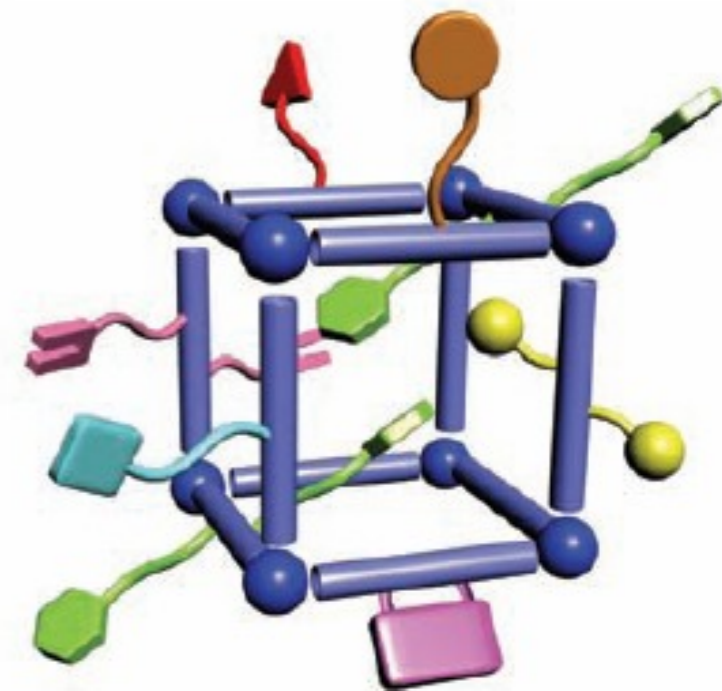

MTV-MOF-5 structure  
with eight different functionalities

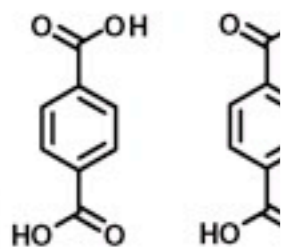
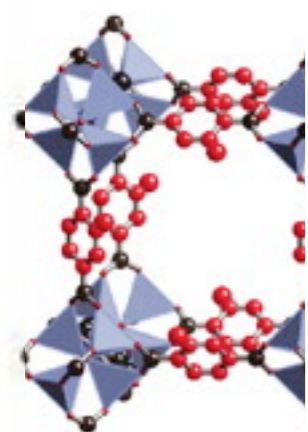

A

E

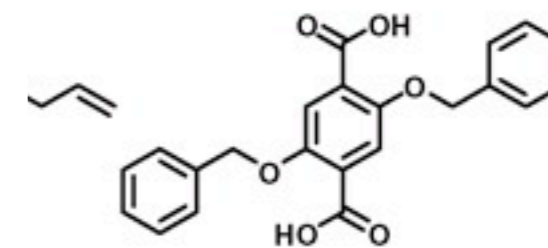
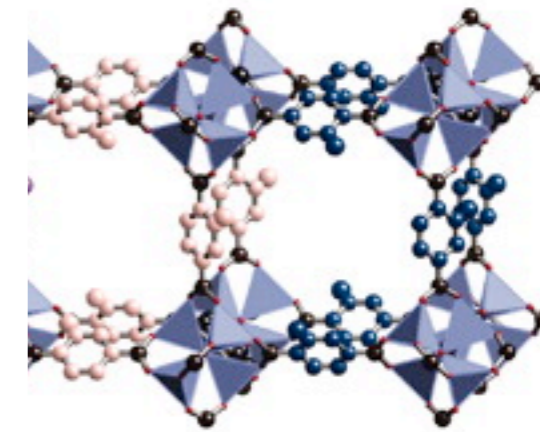
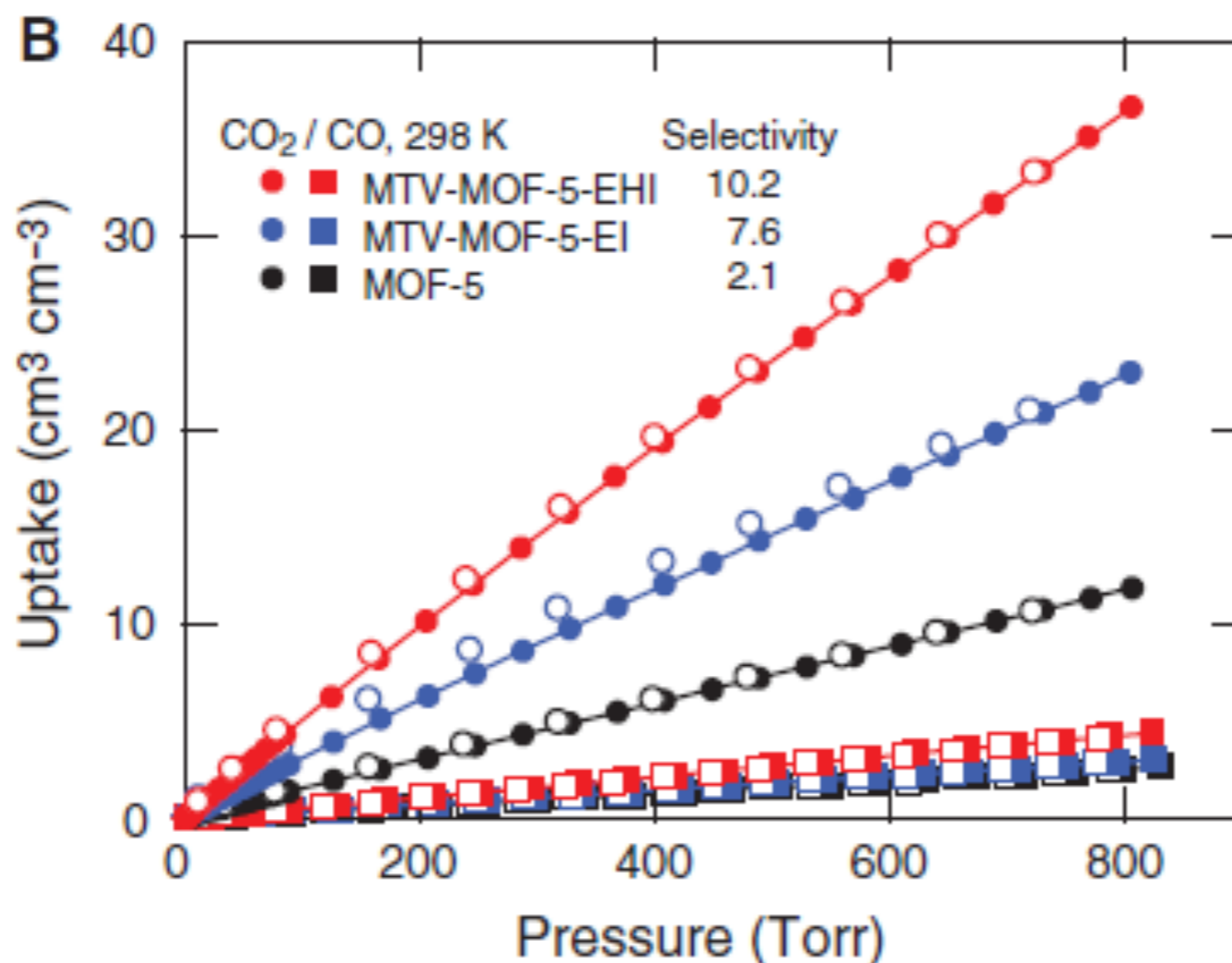

I

❖ Certain MTV-MOFs have better H<sub>2</sub> and CO<sub>2</sub> adsorption properties than MOFs with a single type of linker.

*Deng. et al.  
Science 2010*

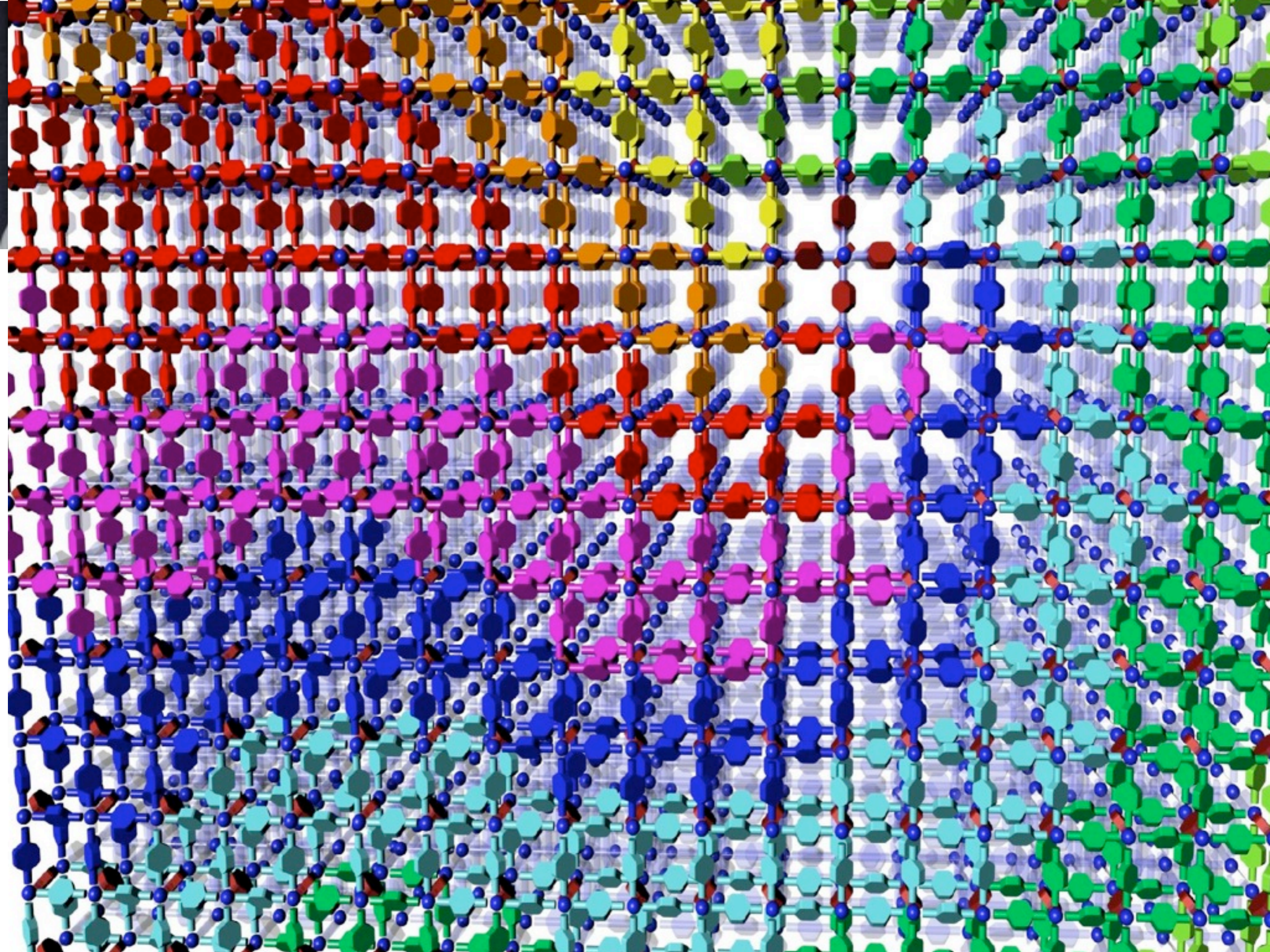

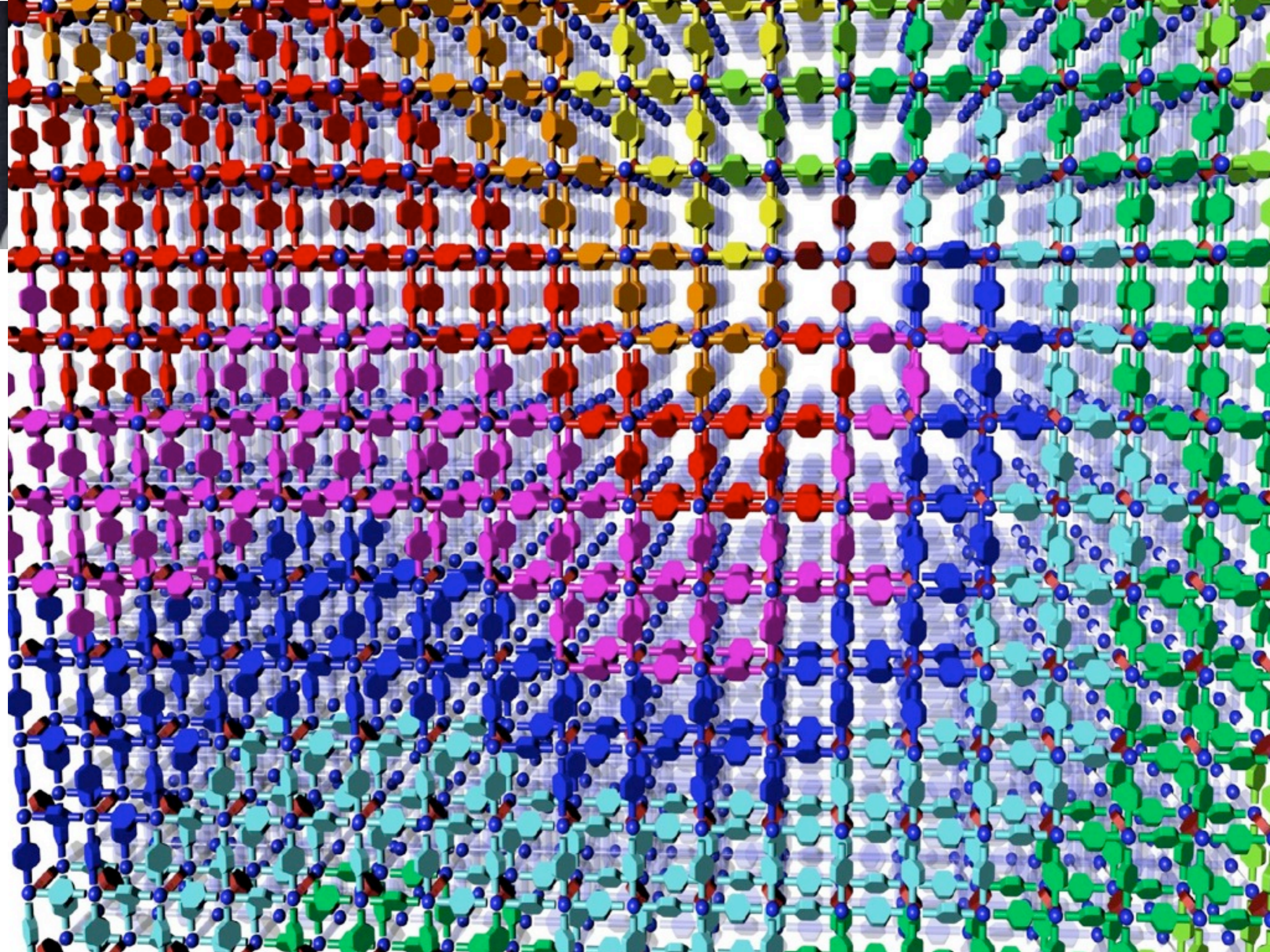

# $^{13}\text{C}\{^{15}\text{N}\}$ REDOR curves

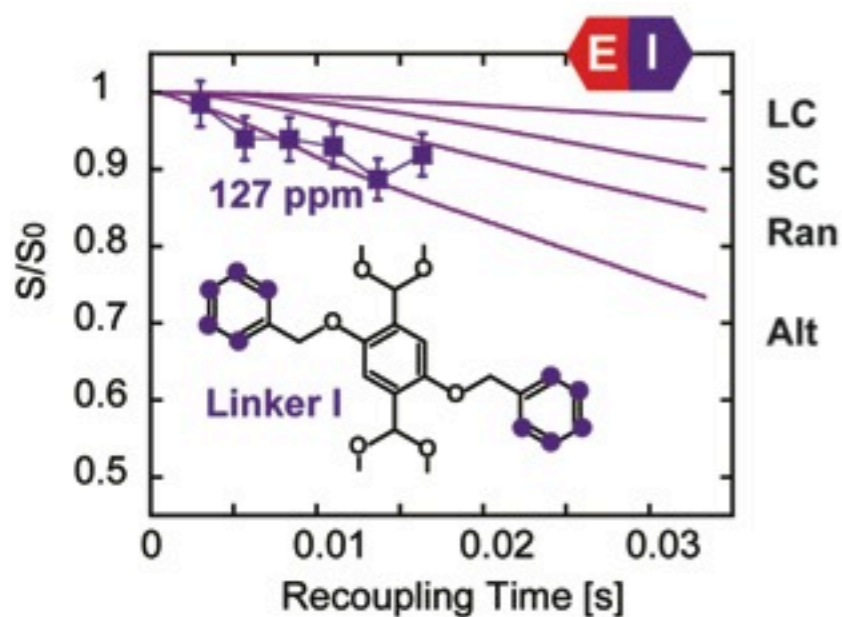
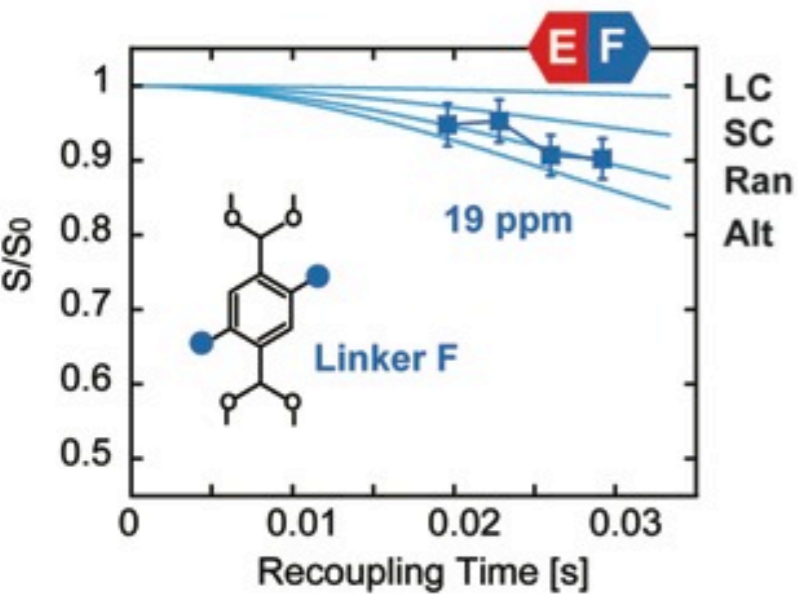
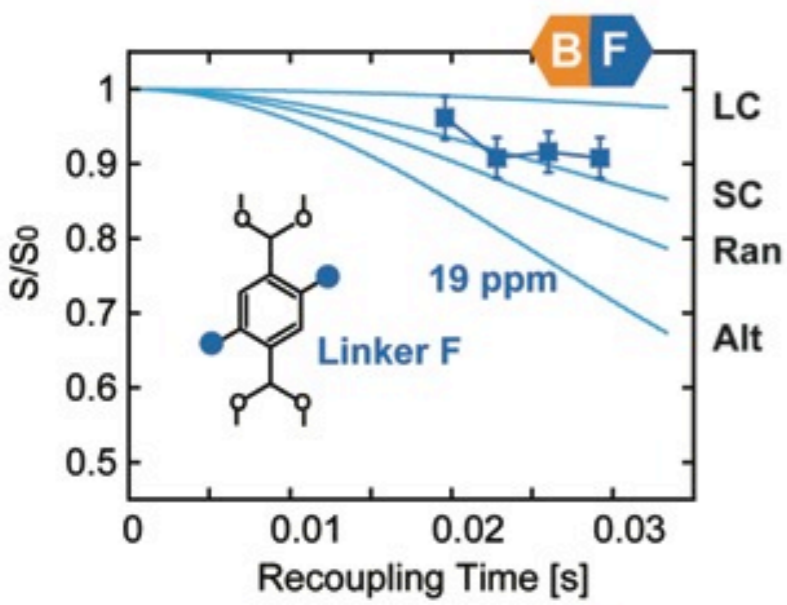

# Scenarios of linker apportionment in MTV-MOF-5 materials

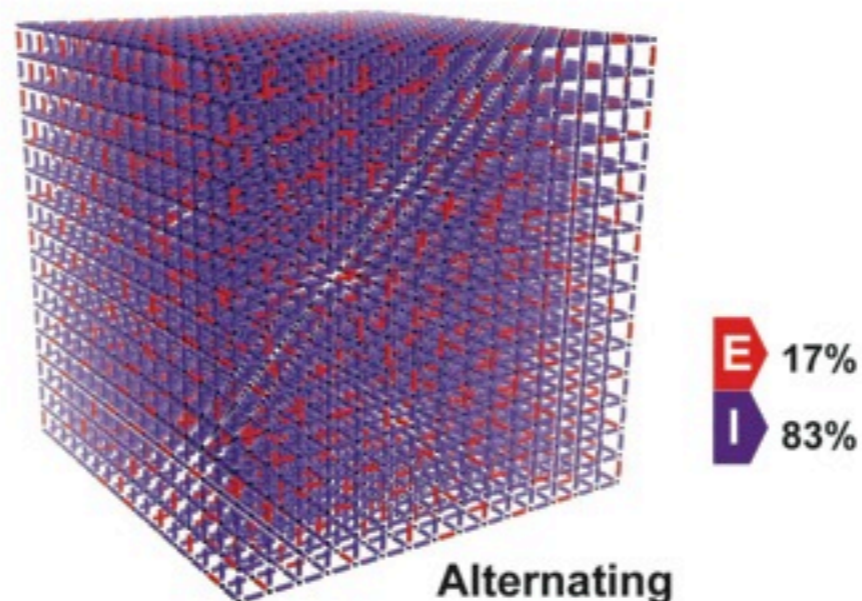
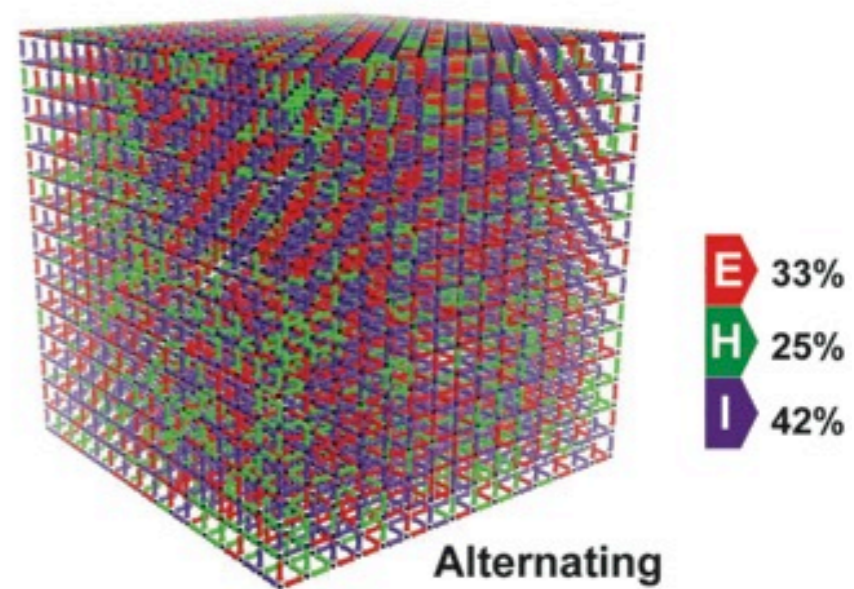
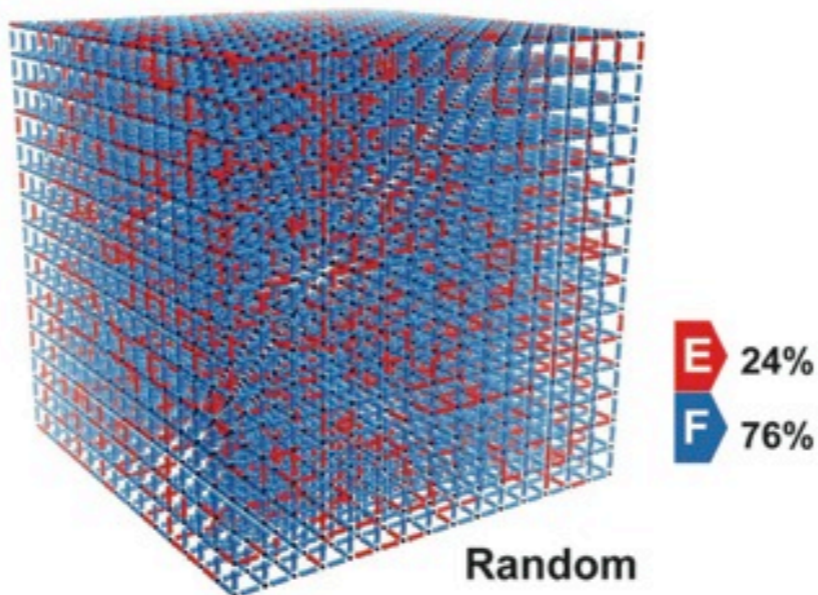
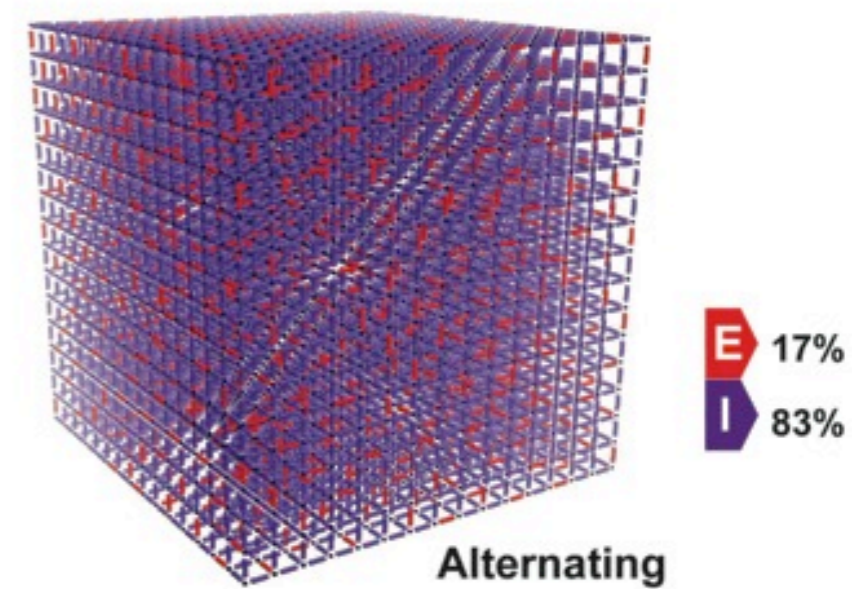
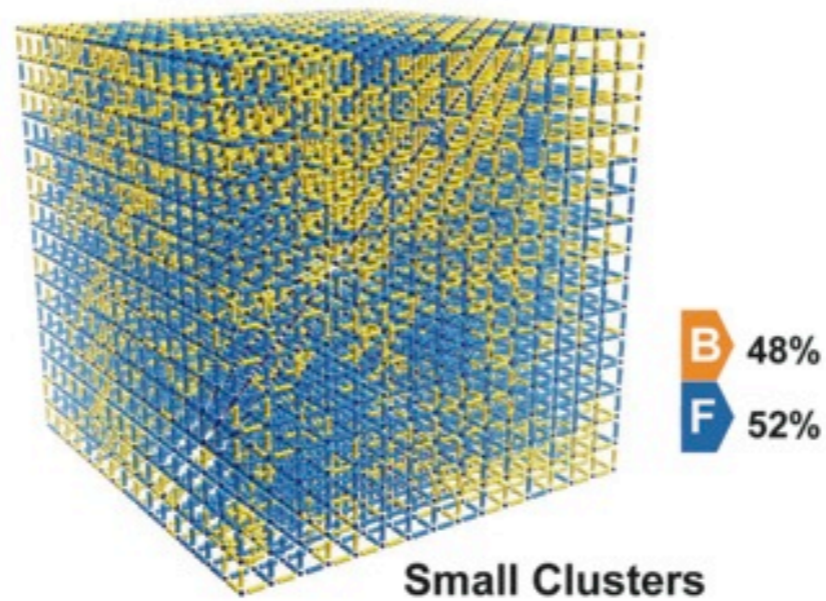

# Apportionment matters

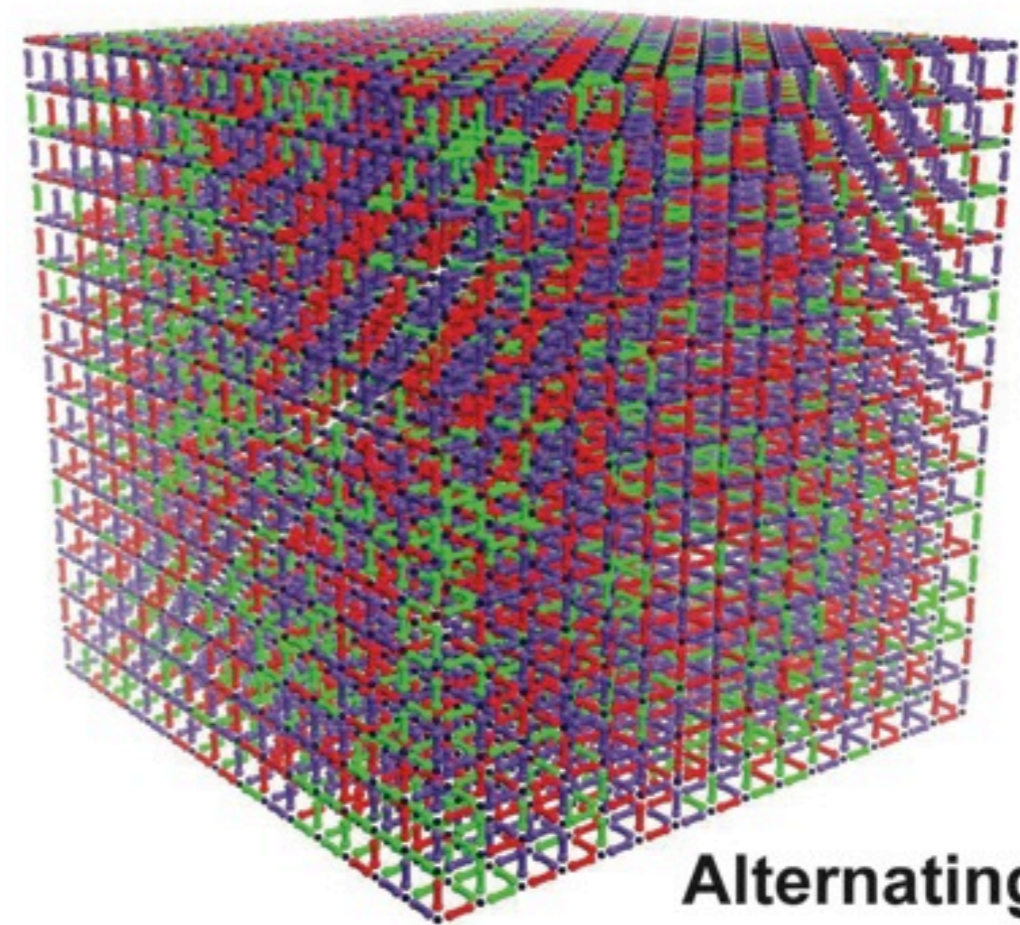

# Apportionment matters

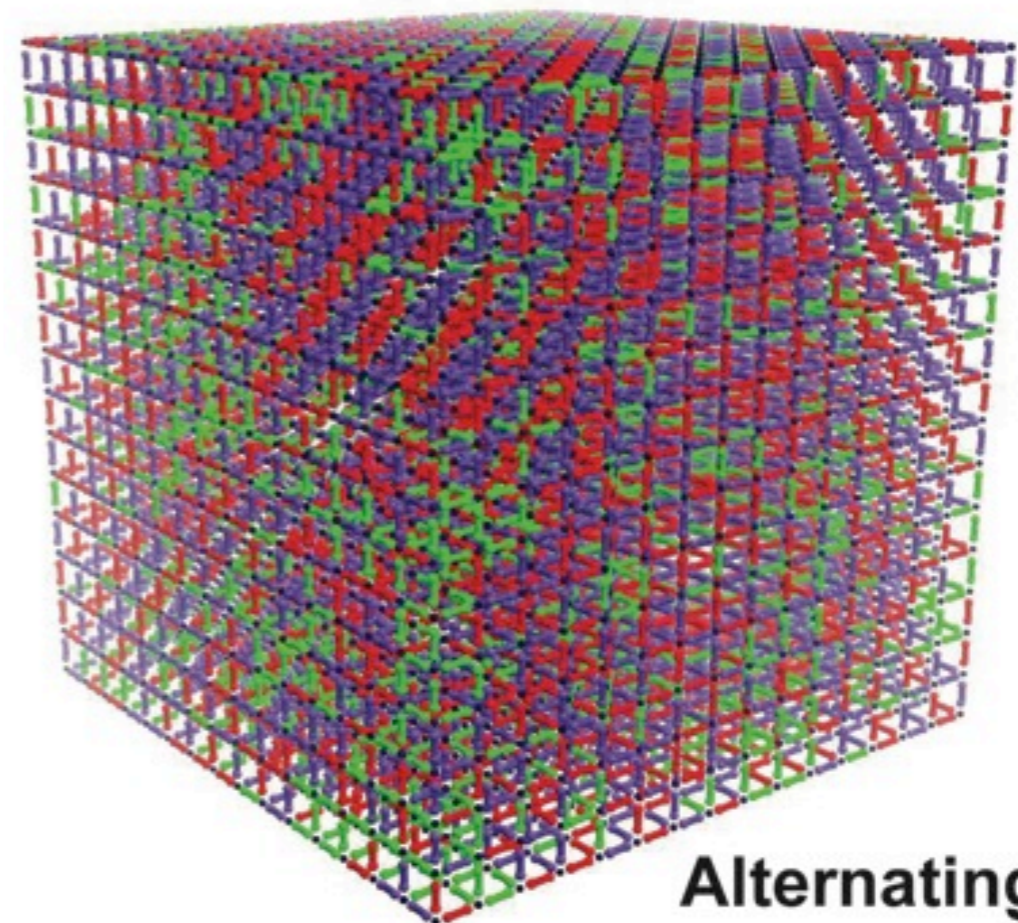
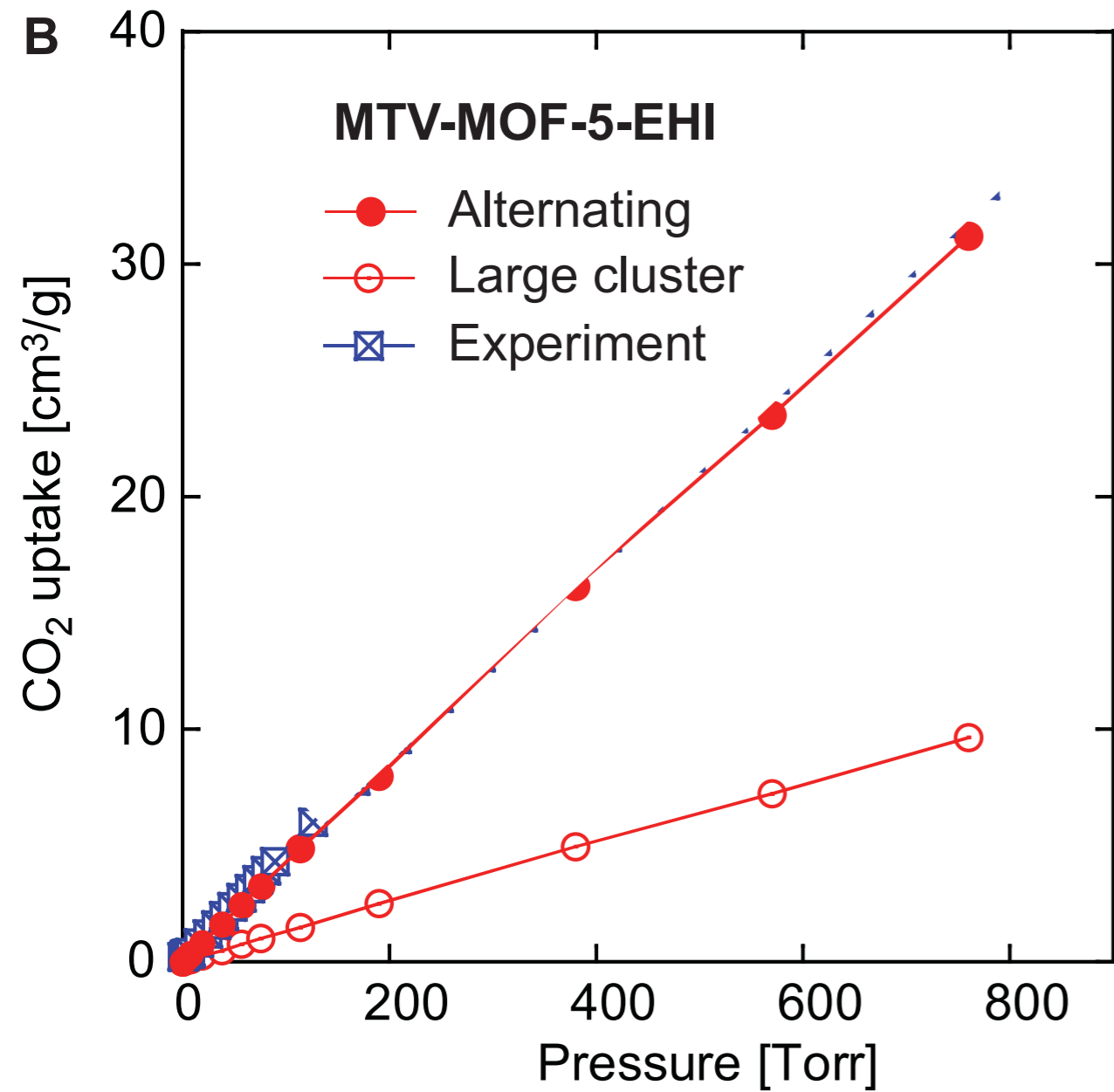

# Apportionment matters

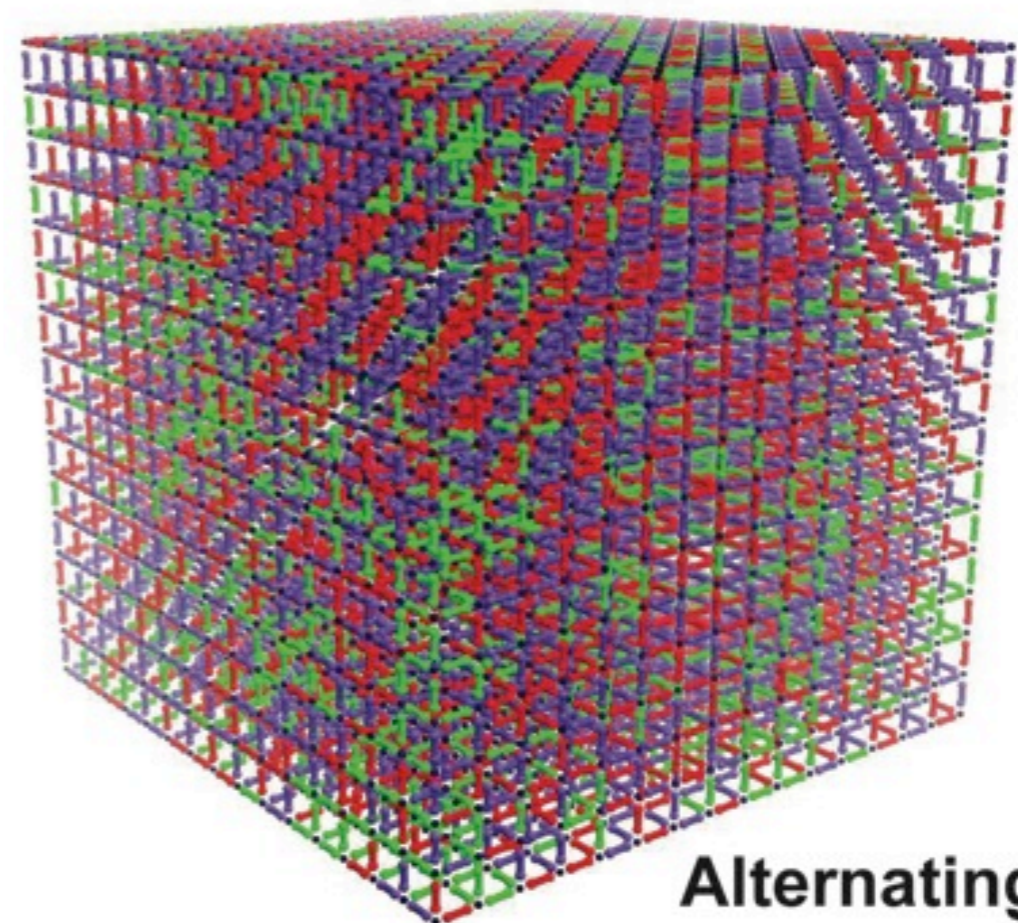
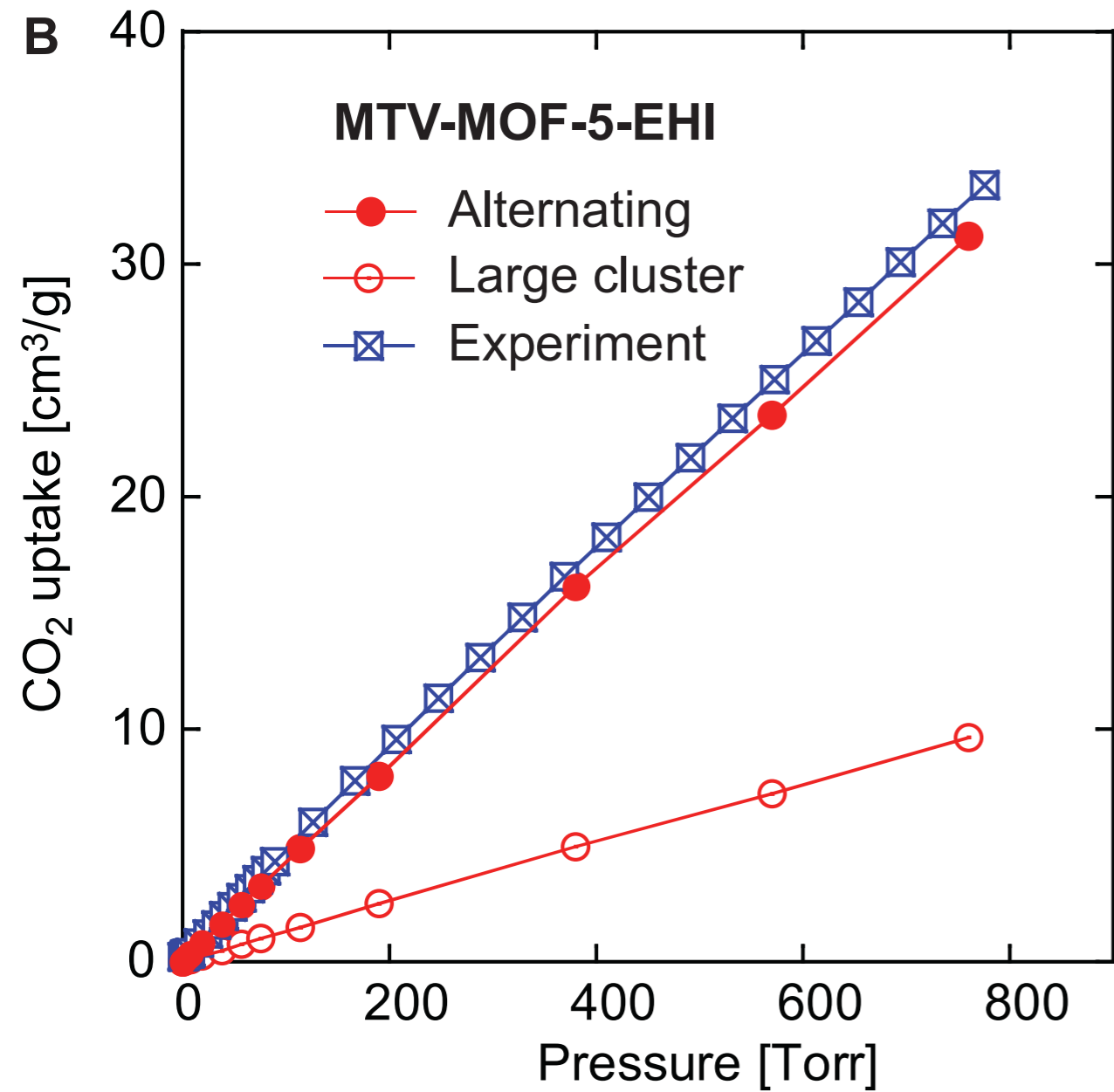



$\text{Mg}_2(2,5\text{-dioxido-1,4-benzenedicarboxylate})$

“Mg-MOF-74”

$\text{CO}_2$  has strong  
affinity for open  
metal sites,  $\text{Mg}^{2+}$

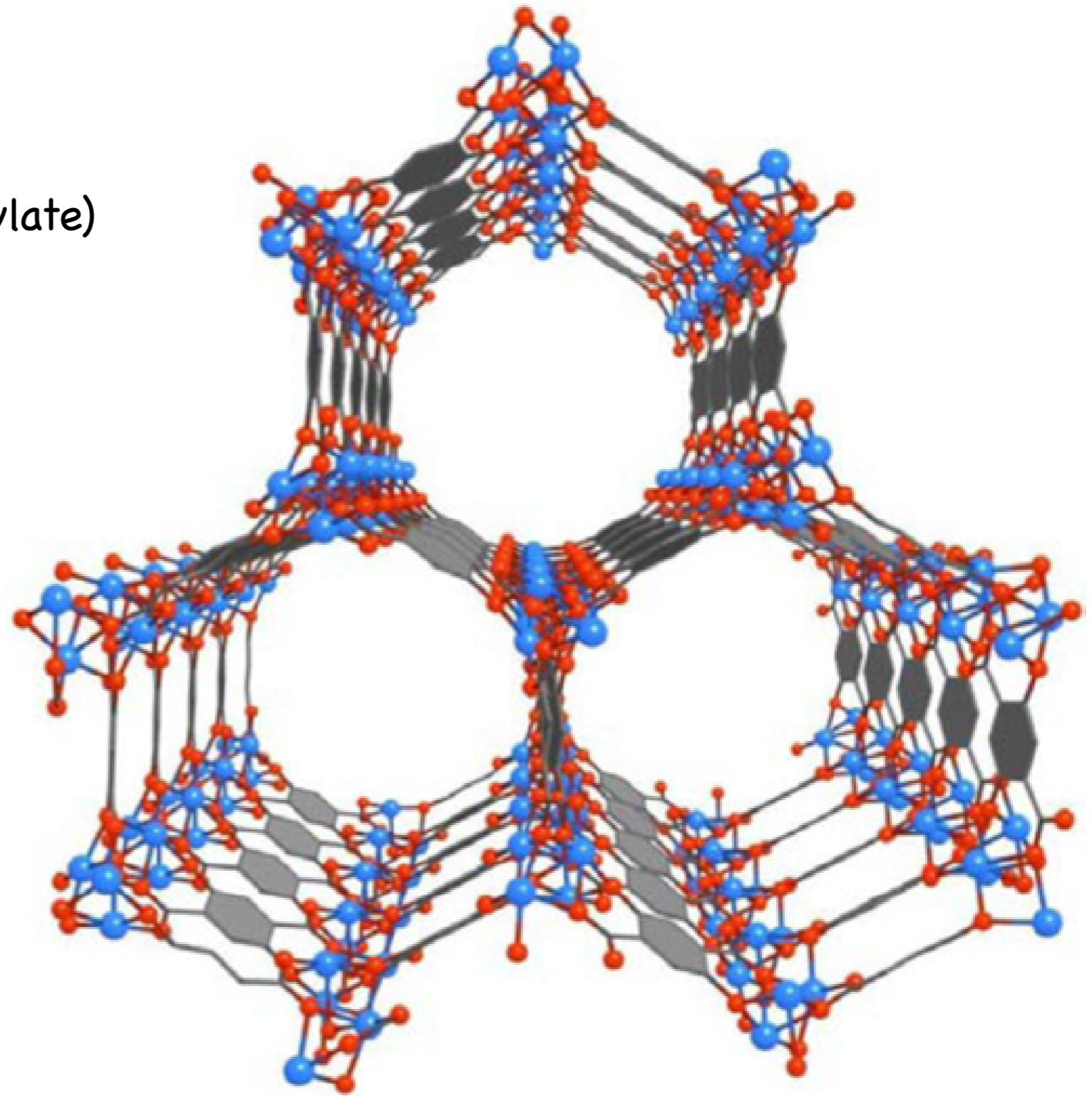

$\text{Mg}_2(2,5\text{-dioxido-1,4-benzenedicarboxylate})$

“Mg-MOF-74”

$\text{CO}_2$  has strong  
affinity for open  
metal sites,  $\text{Mg}^{2+}$

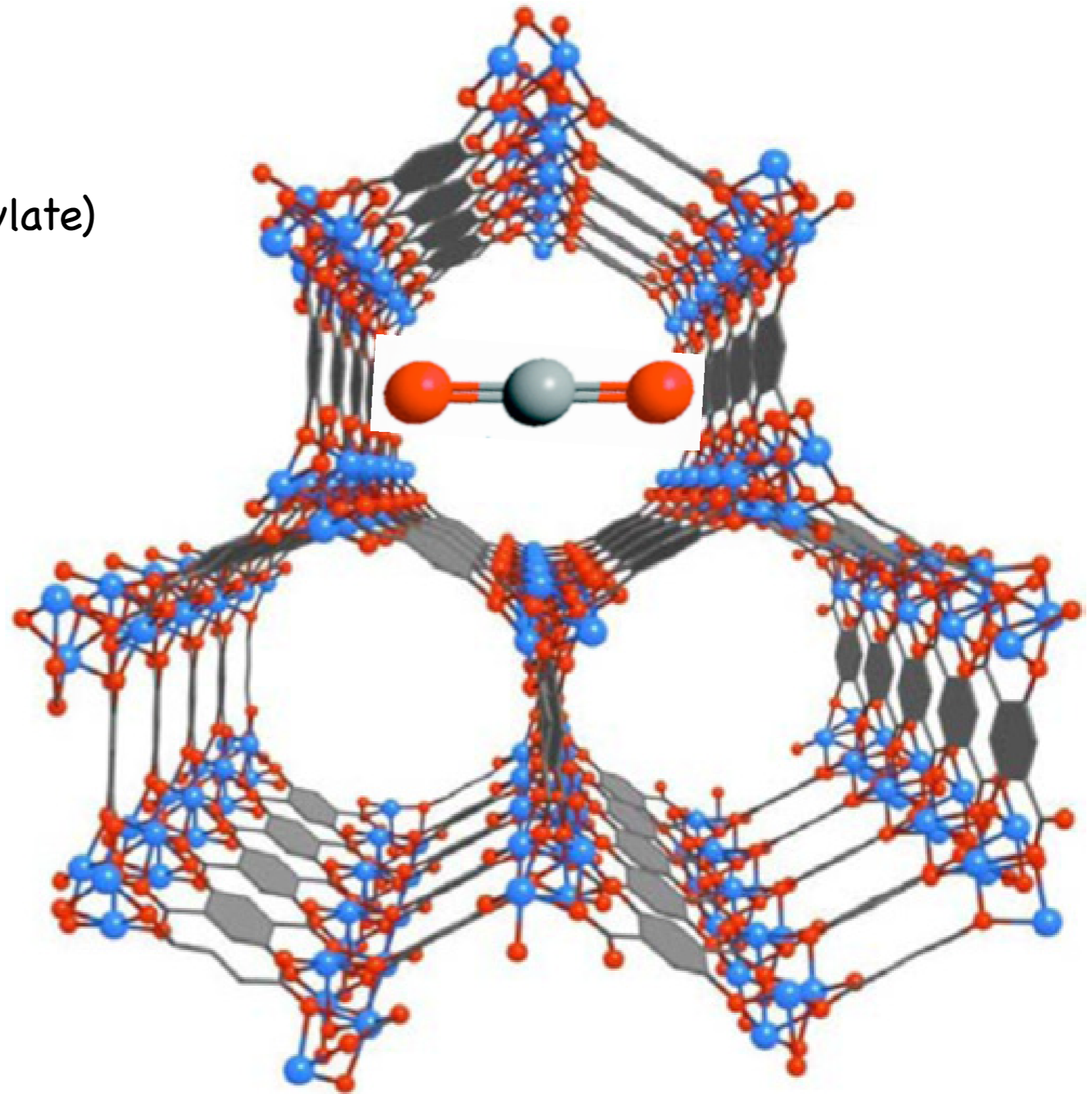

# $^{13}\text{CO}_2$ NMR in Mg-MOF-74

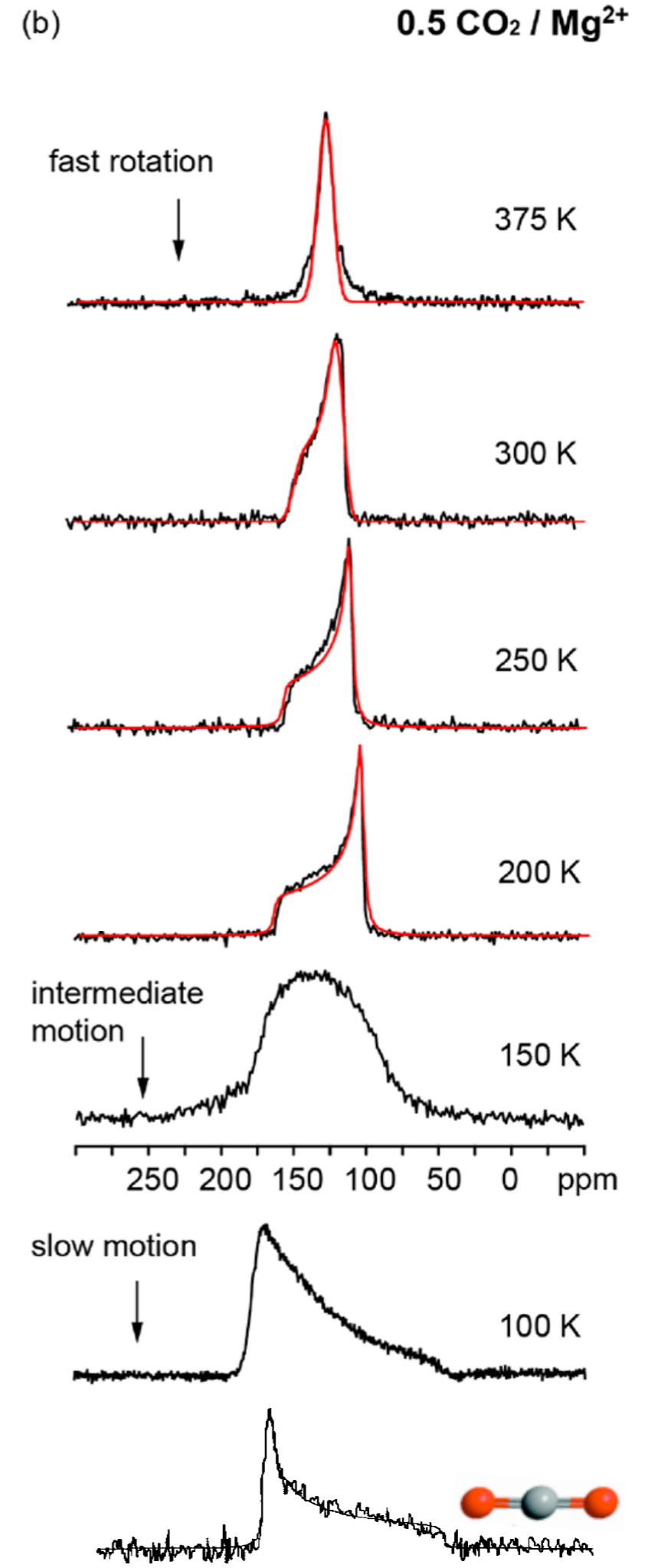

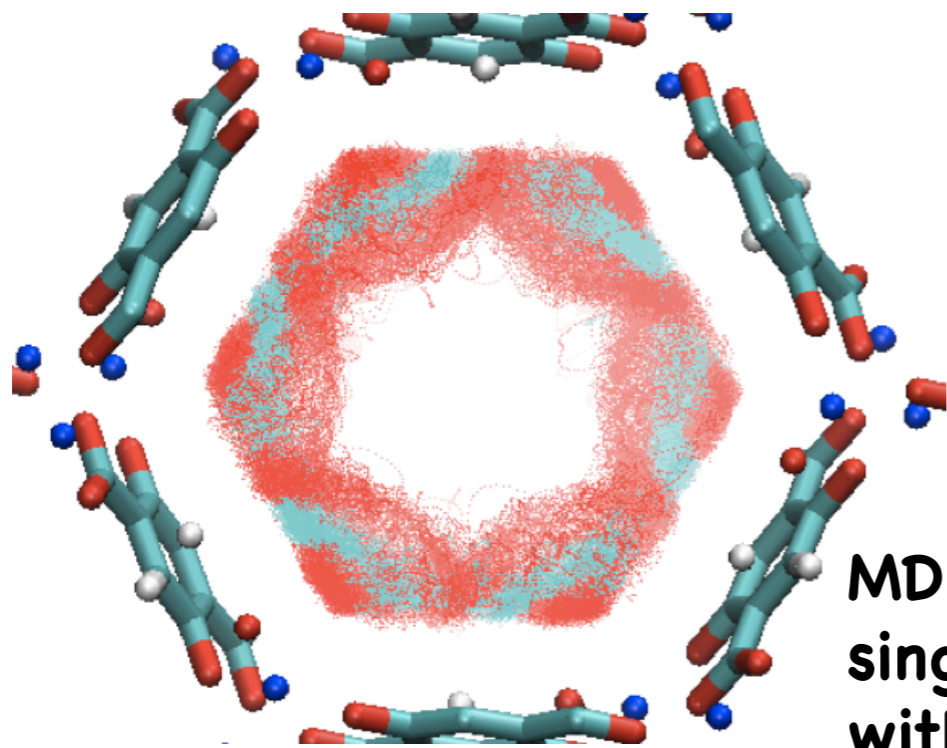

MD trajectories of a single CO<sub>2</sub> at 200 K with the time period of 5 ns in Mg-MOF-74 structure.

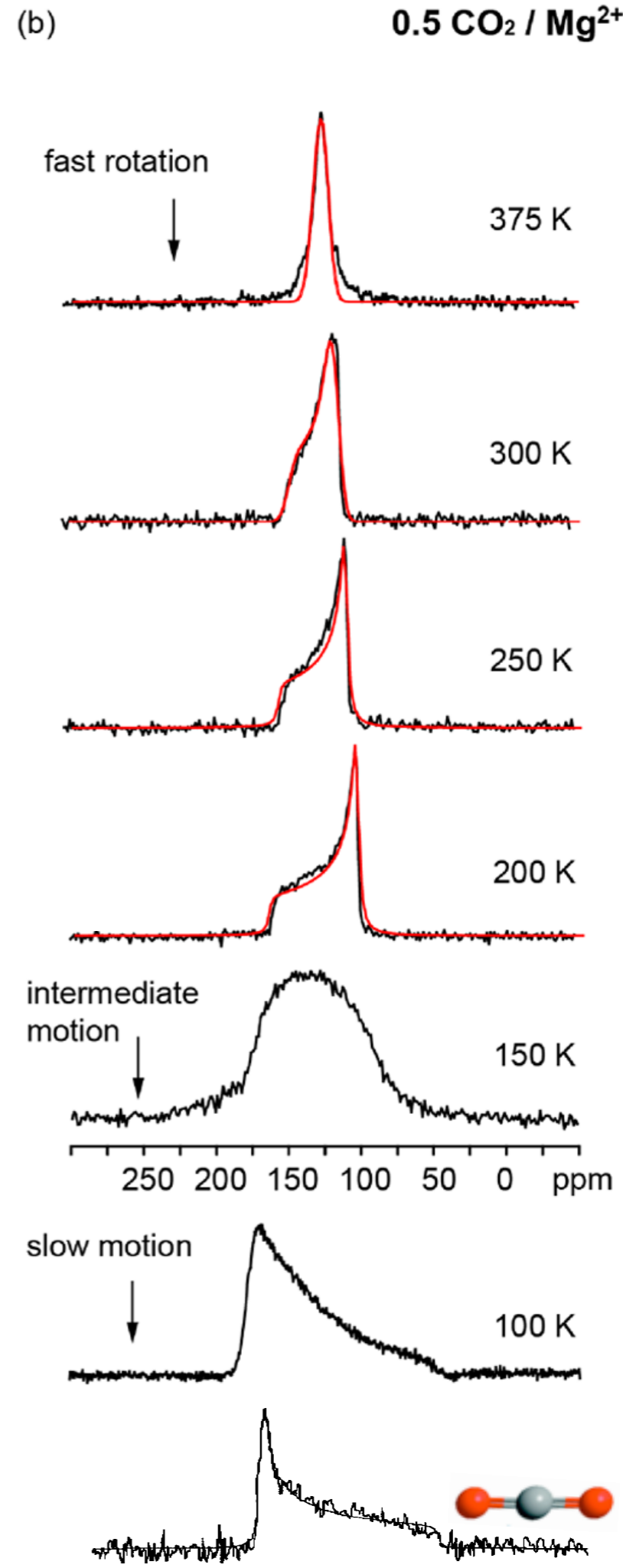

<sup>13</sup>CO<sub>2</sub> NMR in Mg-MOF-74

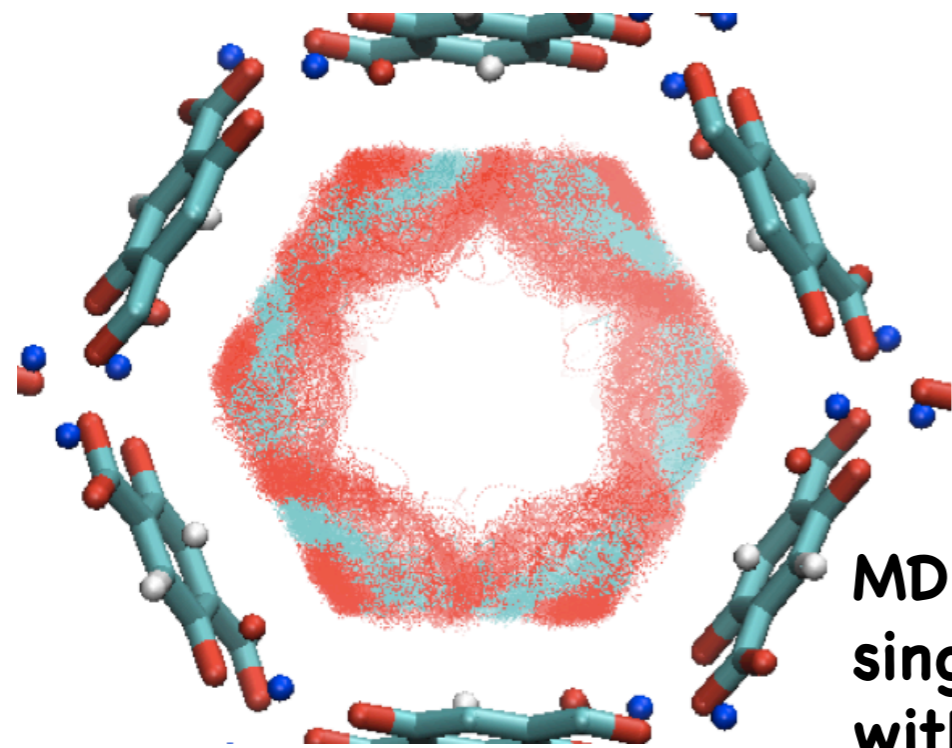

MD trajectories of a single  $\text{CO}_2$  at 200 K with the time period of 5 ns in Mg-MOF-74 structure.

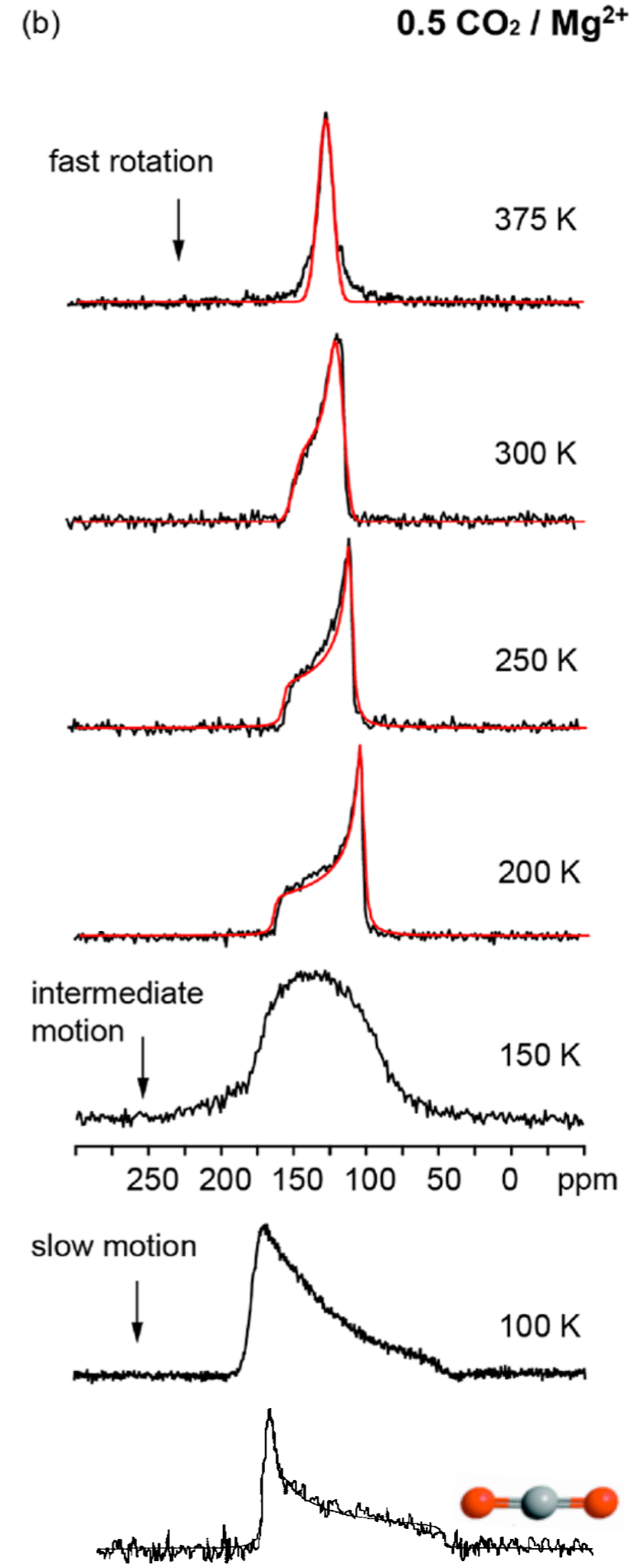
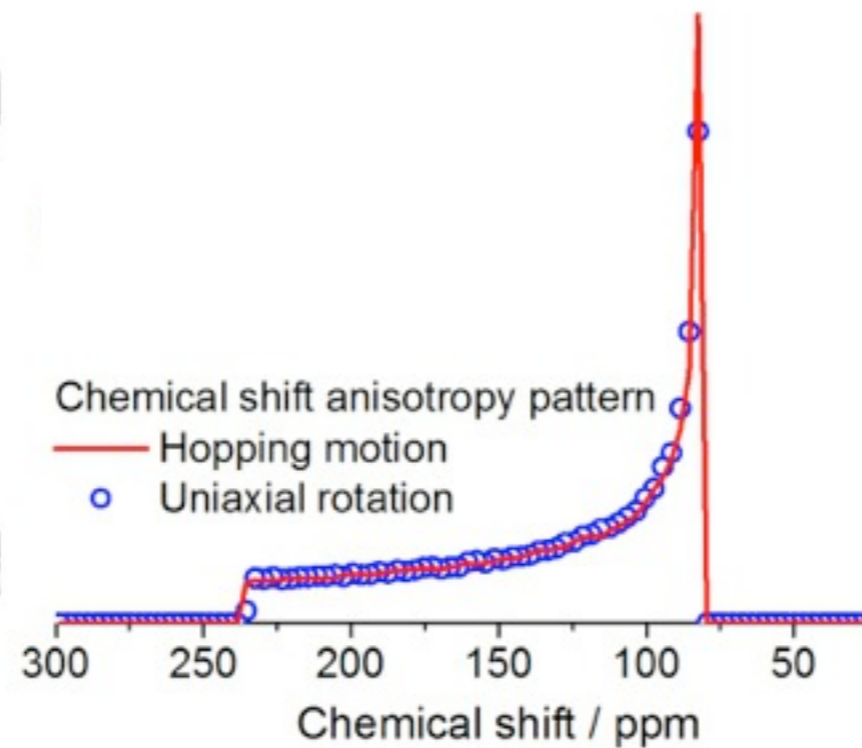
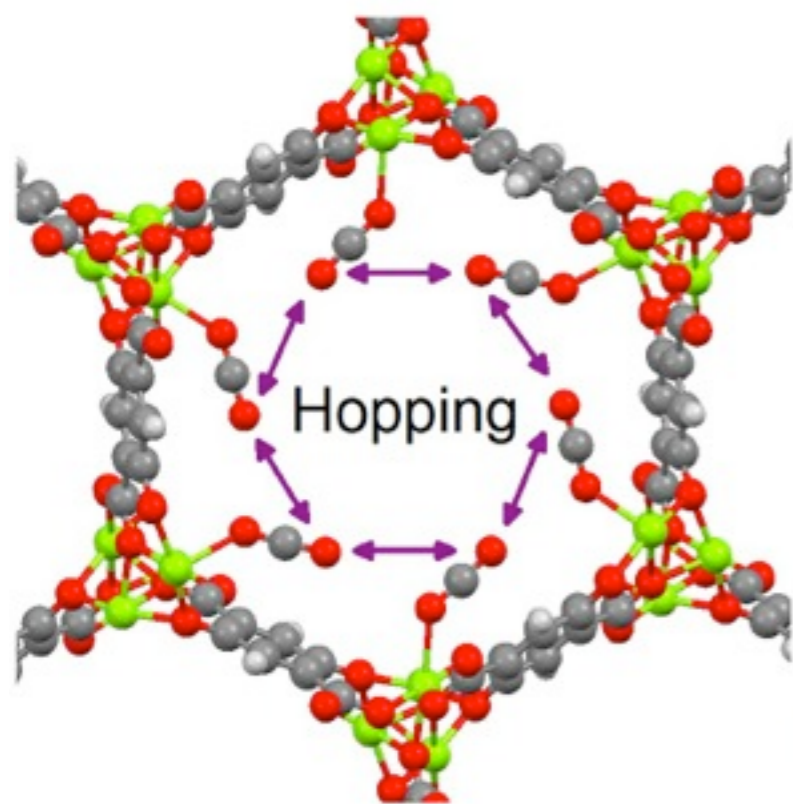

$^{13}\text{CO}_2$  NMR in Mg-MOF-74



**Berend Smit**



**Blandine Jerome**



**Brett Helms**



**David Luebke**



**Frantisec Svec**



**Giulia Galli**



**Hongcai (Joe) Zhou**



**Jeff Kortright**



**Jeffrey Long**



**Jeffrey Neaton**



**Jeffrey Reimer**

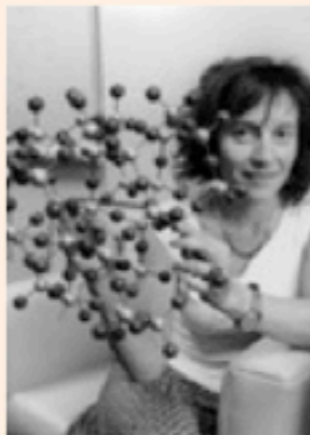

**Laura Gagliardi**



**Maciej Haranczyk**



**Omar Yaghi**



**Simon Teat**



**Ting Xu**



# High-Throughput Discovery of Robust Metal-Organic Frameworks for CO<sub>2</sub> Capture



*Jeffrey A. Reimer,<sup>4</sup> Tae-Hyun Bae,<sup>1,2</sup> Adam H. Berger,<sup>3</sup> Joseph Chen,<sup>4</sup> Justin J. Dutton,<sup>5</sup> Kuldeep Jariwala,<sup>2</sup> Jihan Kim,<sup>2</sup> Sean Kong,<sup>4</sup> Li-Chiang Lin, Richard L. Martin,<sup>6</sup> Jarad A. Mason,<sup>1</sup> Thomas M. McDonald,<sup>1</sup> Ken J. Micklash,<sup>5</sup> Roger Sathre,<sup>7</sup> Kenji Sumida,<sup>1</sup> Joseph A. Swisher,<sup>2,4</sup> Abhoyjit S. Bhowm,<sup>3</sup> Maciej Haranczyk,<sup>6</sup> Steven Kaye,<sup>5</sup> Jeffrey R. Long,<sup>1,2</sup> Eric Masanet,<sup>7</sup> Berend Smit<sup>1,2,4</sup>*

<sup>1</sup>Department of Chemistry, University of California Berkeley, <sup>2</sup>Materials Sciences Division, Lawrence Berkeley National Laboratory, <sup>3</sup>Electric Power Research Institute (EPRI), <sup>4</sup>Department of Chemical and Biomolecular Engineering, University of California Berkeley, <sup>5</sup>Wildcat Discovery Technologies Inc., <sup>6</sup>Computational Research Division, Lawrence Berkeley National Laboratory, <sup>7</sup>Environmental Energy Technologies Division, Lawrence Berkeley National Laboratory

**TUESDAY, JULY 9, 2013 - GRAND STATION I & II**

5:00 p.m.

**Poster Session/Reception – Grand Station III**

# a dizzying array of possibilities...



MTV-MOF-5 structure  
with eight different functionalities

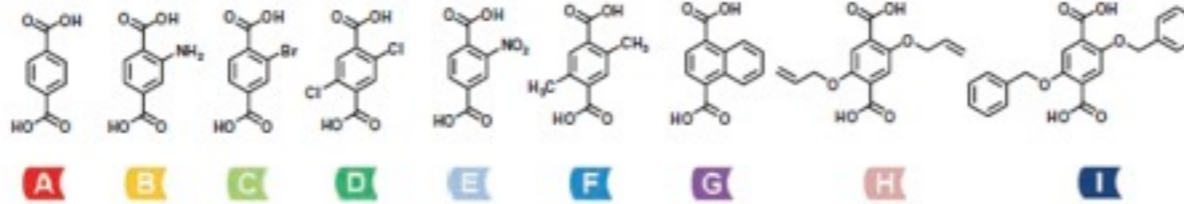
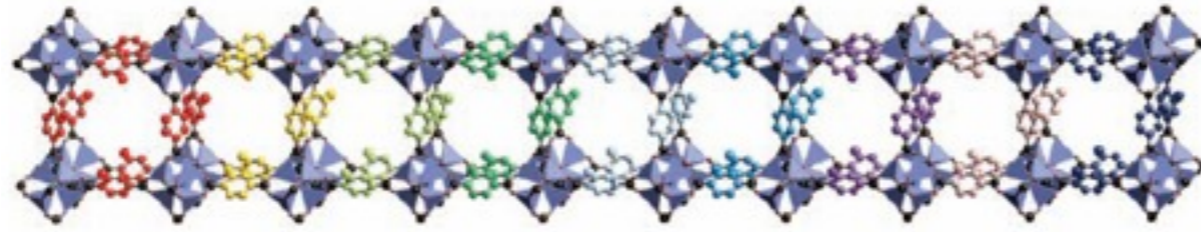



# a dizzying array of possibilities...



MTV-MOF-5 structure  
with eight different functionalities

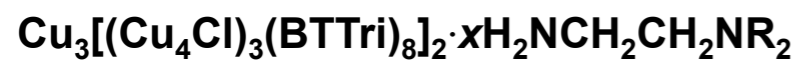
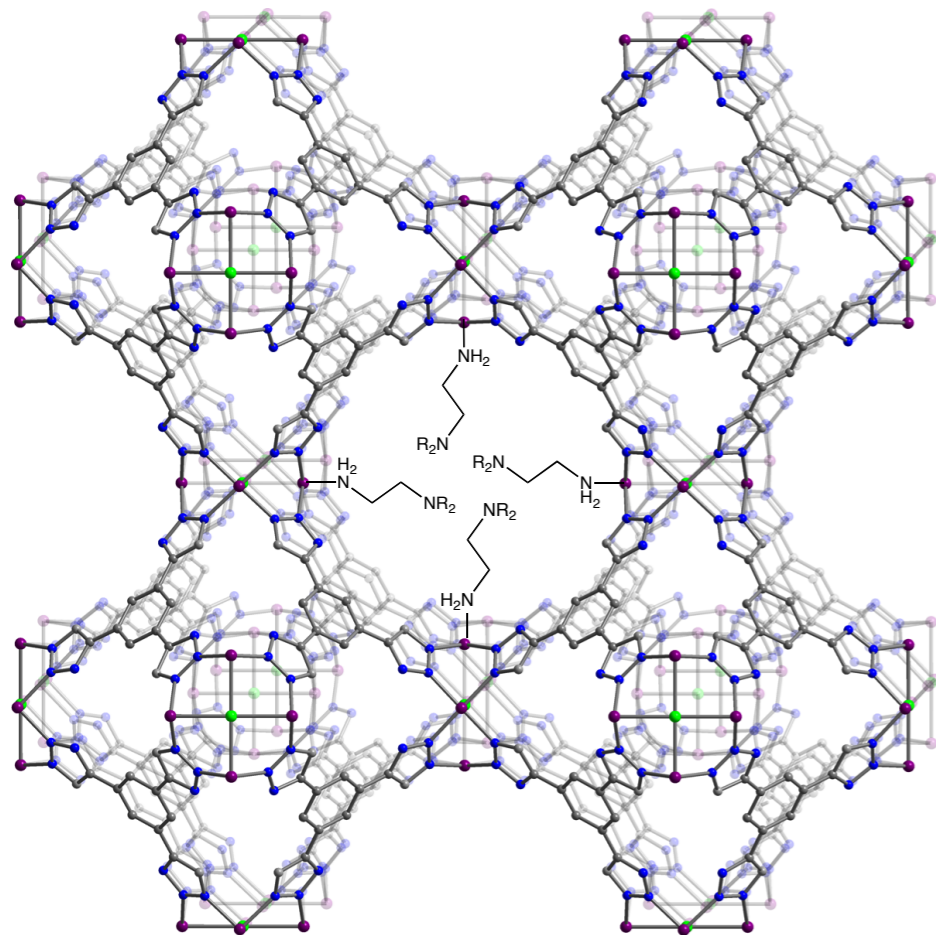
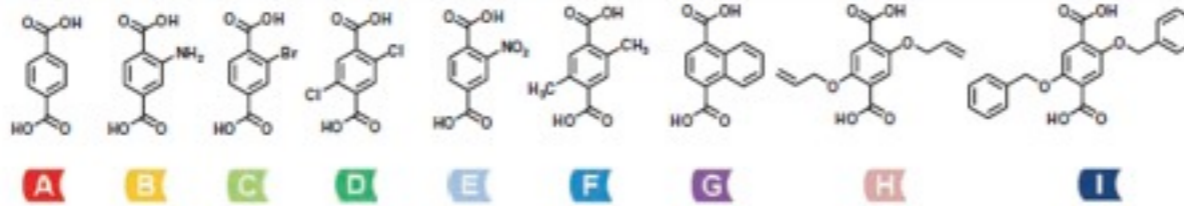
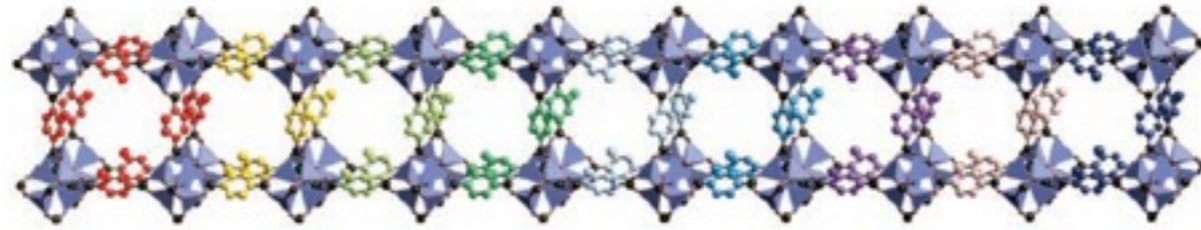

# a dizzying array of possibilities...



MTV-MOF-5 structure  
with eight different functionalities

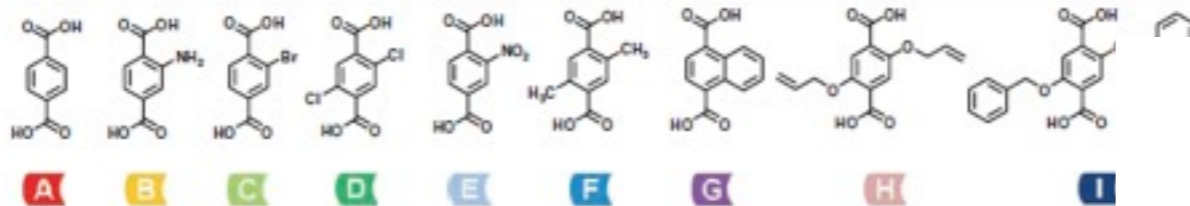
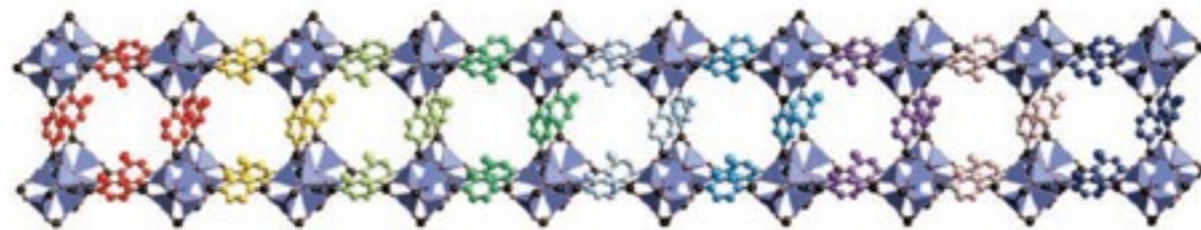

2,5-dioxidoterephthalate  
(DOBDC<sup>4-</sup>)

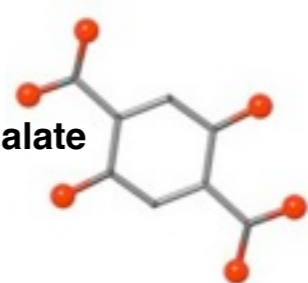

solvent  
exchange  
activation

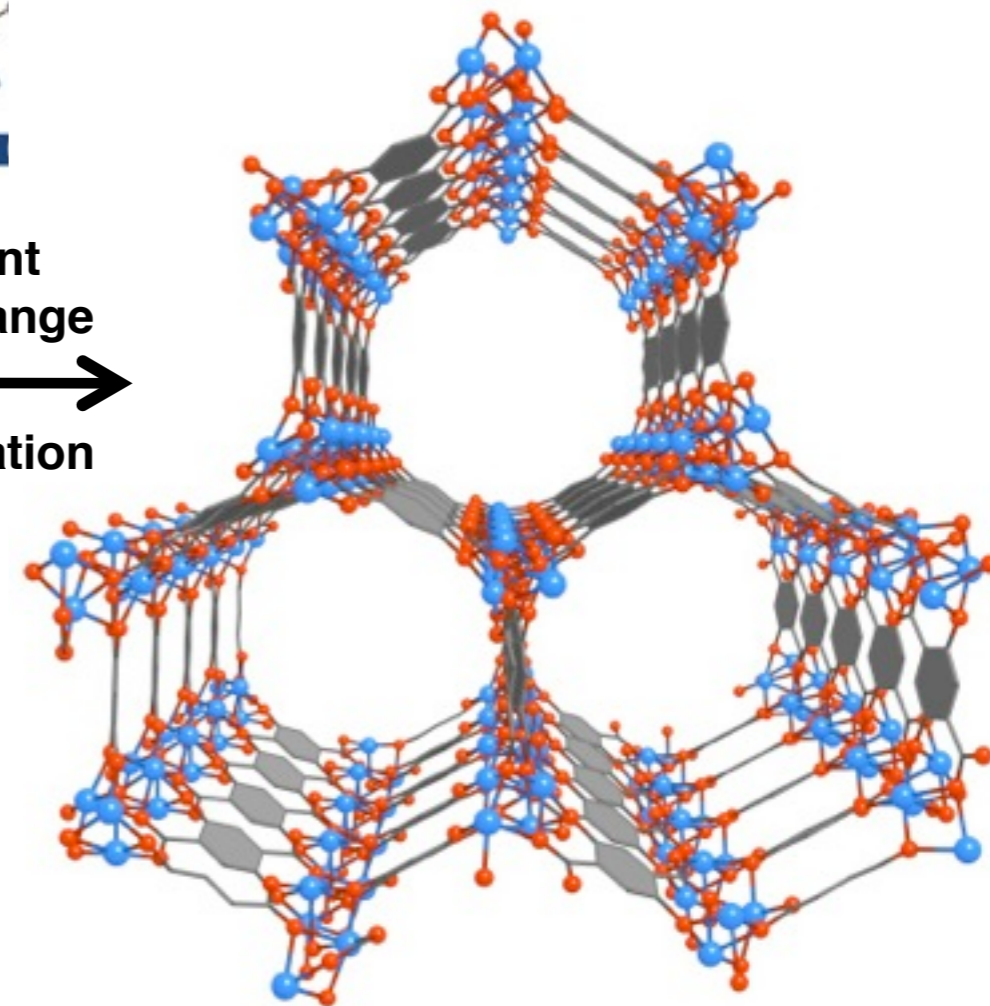

$M_2(DOBDC)$  (M-MOF-74)

(M = Mg, Co, Ni, Zn)

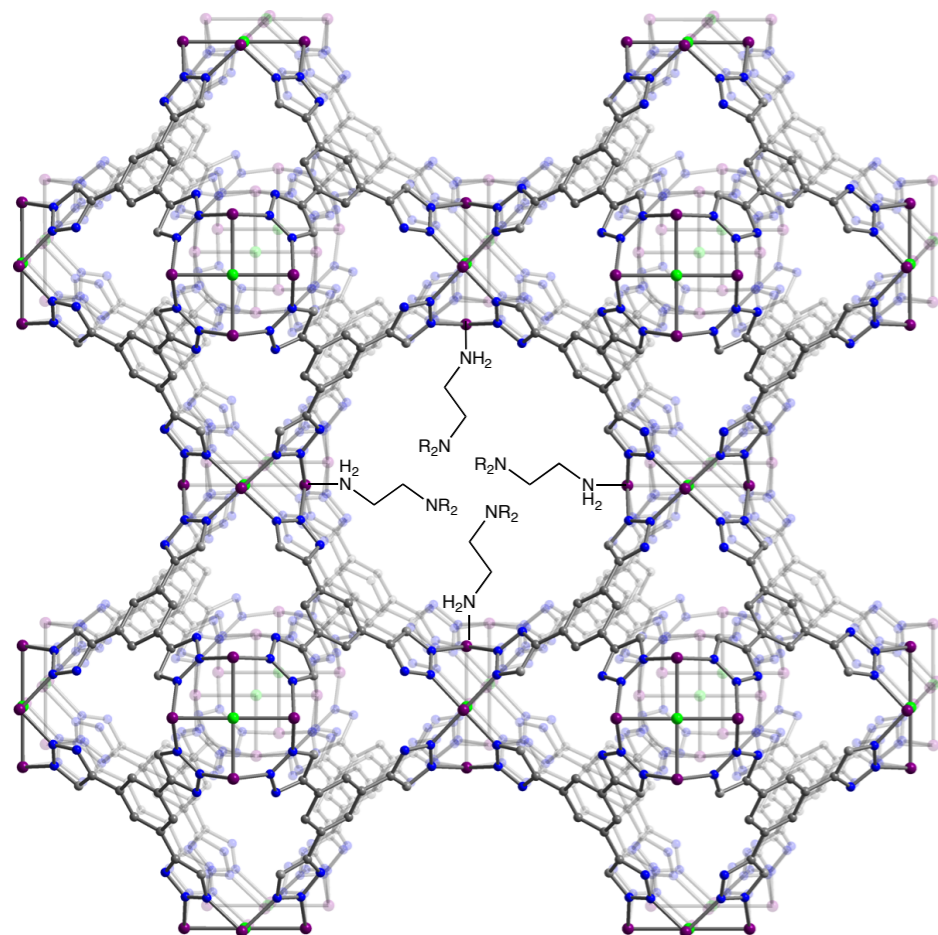

$Cu_3[(Cu_4Cl)_3(BTtri)_8]_2 \cdot xH_2NCH_2CH_2NR_2$

